

K&F CD 44 Digital System Controller



User's Manual

Version 11.7
Released: 09.09.2015



**Important Information,
Please Read Before Use!**

KLING & FREITAG GmbH
Junkersstraße 14
D-30179 Hannover
TEL +49 (0) 511 96 99 70
FAX +49 (0) 511 67 37 94
www.kling-freitag.de



Table of contents

1	Introduction	6
1.1	Symbols in User's Manual	6
1.2	Information about this User's Manual	6
2	Safety Instructions	7
3	General Safety Instructions	7
4	Product Description	8
5	Software and Firmware Update	10
5.1	Use of the CD 44-AutoUpdater	10
5.1.1	Determine update interval	10
5.1.2	Update history	10
6	Connectors, Functions, Controls and Displays	12
6.1	Front	12
6.2	Rear	14
7	Making Adjustments and Navigating Through the Menus	15
7.1	The Use of the Shortcut Buttons	15
7.1.1	Parametric Filters 'PEQ' + SEQ LShelv (Filter A Button)	15
7.1.2	Switchable, Speaker Specific Filters	21
7.1.3	Input and Output Gains (Gain Button)	23
7.1.4	Input and Output Delays (Delay Button)	24
7.2	InfoWindow: Display of Basic Settings	24
7.3	Main Menu	25
7.4	Submenu	25
7.5	Setups in editing mode	25
7.5.1	Editing mode with one editing line	26
7.5.2	Editing mode with several editing lines	26
7.5.3	Editing Mode with Selection Lines	27
7.5.4	Menu Tree of the CD 44 and Explanation of the Functions	28
7.5.5	Functions of the Menu Item 'Setup'	29
7.5.6	Functions of the Menu Items under 'In'	30
7.5.7	Functions of the Menu Items under 'Out'	33
7.5.7.1	9.6.4Functions of the Menu Items under 'Util'	40
8	Routings with Examples of Use and Connecting Diagrams	41
8.1	'Rack Unit' Connecting Diagram for 1 CD 44 and 2 Amplifiers	41
8.2	K&F 'System Rack' Connecting Diagram	42
8.3	Routing '1 in 4 out' / Setup 'Example 1'	43
8.3.1	Block Diagram, 'Example 1'	43
8.3.2	Setup 'Example 1', T5 / T9 with B10 on 2 Channels	43

8.4	Routing '1 in 4 out (Linked)' / Setup 'Example 2'	44
8.4.1	Block Diagram 'Example 2'	44
8.4.2	Setup 'Example 2', 4 x Line 212-6 with 4 x SW 215E	45
8.5	Routing '2 in 4 out' / Setup 'Example 3'	46
8.5.1	Block Diagram 'Example 3'	46
8.5.2	Setup 'Example 3', Line 212/SW 215E & Monitor CA 1215/SW 115E	46
8.6	Routing '2 in 4 out (Linked)' / Setup 'Example 4'	47
8.6.1	Setup 'Example 4', Line 212 / SW 215E, stereo	48
8.7	Routing '4 in 4 out' / Setup 'Example 5'	49
8.7.1	Block Diagram 'Example 5'	49
8.7.2	Setup 'Example 5', 4- Way Monitor Setup	49
8.8	Routing '1 in 2 + 2 in 2' / Setup 'Example 6'	50
8.8.1	Block Diagram 'Example 6'	50
8.8.2	Setup 'Example 6', Front: CA1515 / SW118E + 2 Adjoining Rooms	50
8.9	Routing '1 in 3 + AUX' / Setup 'Example 7'	51
8.9.1	Block Diagram 'Example 7'	51
8.9.2	Setup 'Example 7', 3 x SEQUENZA 10 B Cardioid + SW 115 E	51
8.10	Routing '1 in 4 in 4' / Setup 'Example 8'	52
8.10.1	Block Diagram 'Example 8'	53
8.10.2	Setup 'Example 8', Delay-Line	53
8.11	Routing '1 in 3 + 1 in 1' / Setup 'Example 9'	54
8.11.1	Block Diagram 'Example 9'	54
8.11.2	Setup 'Example 9', T5 / T9 with B5 and additional Bass B10	54
8.12	Routing '2 in 4 in 4' / Setup 'Example 10'	56
8.12.1	Block Diagram 'Example 10'	56
8.12.2	Setup 'Example 10	56
8.13	Routing '1 in 2 + Aux + 1 in 1' / Setup 'Example 11'	57
8.13.1	Block Diagram 'Example 11'	57
8.13.2	Setup 'Example 11	57
8.14	Patching: Analog 1&2 Mix / Routing '2 in 4 in 4' / Setup 'Example 12	58
8.14.1	Block Diagram 'Example 12'	58
8.14.2	Setup 'Example 12'	59
8.15	Sequenza 10 N / W Routing '1 in 4 out' / Setup 'Example 13'	59
8.15.1	Block Diagram 'Example 13'	60
8.15.2	Setup 'Example 13'	60
8.16	Sequenza 10 N / W: Routing '1 in 2 + Aux + 1 in 1' / Setup 'Example 14'	61
8.16.1	Block Diagram 'Example 14'	61
8.16.2	Setup 'Example 14'	62
8.17	Patching: Analogue 1&2 Mix / Routing '1 in 2 in 2 + 2 in 2' / Setup 'Example 15'	64
8.17.1	Block diagram, 'Example 15'	64

8.17.2	Setup 'Example 15'	64
9	Subwoofer with integrated Crossover	64
10	SP Speakers	65
11	Recommendations for Configuration	66
11.1	Operating several Speakers per CD 44 Channel	66
11.2	The correct Level Balance between Subwoofer and Top Speakers	66
11.2.1	SW 112 / SW 115D / SW 115E / SW 118E	66
11.2.2	SW 215E / ACCESS B5 & B10 / SEQUENZA 10 B / NOMOS XLC	69
12	Instructions for AES / EBU Data Transmission	71
12.1	General Instructions	71
12.2	Transmissions over long Distances	72
13	Wiring	72
14	Operating the Speakers	72
15	Technical Specifications CD 44	74
16	Disposal	76
16.1	Germany	76
16.2	EU, Norway, Iceland, and Liechtenstein	76
16.3	All other Countries	76
17	EC Declaration of Conformity	77

1. Introduction

Thank you for your decision to buy a KLING & FREITAG product. To guarantee a trouble-free operating of the equipment and to allow your device to achieve its full potential please read the operating instructions carefully before use.

With the purchase of the CD 44 Controller, you have acquired a device with the highest possible quality and performance capabilities.

As the owner of this system, you now have a versatile and highly professional tool which, when operated properly, is a true pleasure to use.

1.1 Symbols in User's Manual



Warning

This symbol indicates the possibility of life-threatening danger and a health risk for persons. Not following these instructions may result in serious health problems including potentially fatal injuries.



Caution

This symbol indicates a possibly dangerous situation. Not following these instructions may cause minor injuries or cause property damage.



Notice

This symbol gives instructions for the proper use of the described products. Not following these instructions may cause malfunctions or property damage.



Tip

This symbol indicates notes that help you to handle the described products easier.

1.2 Information about this User's Manual

© KLING & FREITAG GMBH, all rights reserved.

All specifications in this manual are based on information available at the time of publishing for the features and safety guidelines of the described products.

Technical specifications, measurements, weights and properties are not guaranteed.

The manufacturer reserves the right to make product alterations within legal provisions as well as changes to improve product quality.

All persons who use the speaker system must have this guide and all further information for safe operations available to them during assembly, disassembly, and use. The speaker system may neither be set up nor used until this manual has been read, understood and kept readily available on site.

We appreciate any input with suggestions and improvements for this manual. Please send this to us at the following address:

info@kling-freitag.de or to:

KLING & FREITAG GMBH Junkersstr.14 D-30179 Hannover.

Phone +49 (0) 511 96 99 70, Fax +49 (0) 511 67 37 94.

2. Safety Instructions



Danger

This symbol indicates the possibility of life-threatening danger and a health risk for persons. Not following these instructions may result in serious health problems including potentially fatal injuries.



Warning

This symbol indicates a possibly dangerous situation.

Failure to follow these instructions can lead to malfunctions in the product or in the environment.



Caution

This symbol gives instructions for the proper use of the described products.

Failure to follow these instructions can lead to malfunctions in the product or in the environment.

3. General Safety Instructions

Do not install devices in any of the following places:

- where the units are permanently exposed to direct sunlight.
- near other heat sources or open fire.
- where the airflow for cooling is blocked.
- where the devices are exposed to high moisture.
- where the devices are exposed to strong vibrations and dust.

Power supply

Before connecting to the power supply system, check if the local voltage matches the voltage marked on the device. The device then needs to be adapted to the required mains voltage by Kling & Freitag or an authorized service centre. Connect the device under any circumstances, to an unauthorized power supply source. This could irreparably ruin the device.

Make sure that the power outlet supplies a ground connector, which must be connected to the device via the PE conductor of the power cord!

All devices interconnected over signal lines with connection to a protective earth must be connected to a common protective earth. If not, there is a risk of an electric shock or the destruction of the connected equipment. The power plug must always be used to disconnect from the power supply. Furthermore, the power plug must be easily accessible for use at all times.

Protection of electrical cables

Power cables should be routed so that they are protected against impact damage and tensile stress caused by jamming between objects.

Transportation

When transporting the device, make sure that it is protected from vibrations.

Cleaning

The equipment should only be cleaned with a damp cloth when it is not plugged in.

Pauses in use

The power cord should be disconnected from the power source during longer pauses in use.

Intrusion of liquids

It should always be ensured that no liquids get into the device.



Warning

Maintenance and technical service

The user should not perform any maintenance or repair work on the unit which goes beyond the work described in this manual. This must be carried out by qualified specialist staff.

The device may only be repaired by qualified specialist staff when, for example:

- the power cord or the mains connector have been damaged.
- objects or liquids have gotten into the device.
- the device has been exposed to rain.
- the device doesn't appear to be functioning properly.
- it has fallen down or the housing is damaged.

Unwanted interference

RF interference on the power cord or on the line signal cables may lead to unwanted sound interference.

Notice

4. Product Description

The signal processor CD 44 is a digital 4 in 4-way speaker controller that can process both analogue and digital signals in the AES/EBU format up to 192 kHz.

The controller is equipped with the finest AD and DA state-of-the-art converters as well as 3 micro-controllers and 8! integrated signal processors (DSP). It not only offers excellent audio results, but also a multitude of special features and novel functions: CD 44

Multi-level memory concept for parameter management

The parameter sets for almost all K&F speaker systems are saved in the form of macros in the device (the so-called 'LS-Blocks'). They can be copied as a complete set of data and independently of one another into each of the 4 output channels.

The specification of one K&F phase reference for multi-way operations is advantageous because of its high level of compatibility. Without requiring phase adjustments, the various K&F tops can be combined with all K&F subwoofers.

Additional LS-Blocks 'Flat' facilitate the integration of third-party products (with limitations) or the processing and linking of signals to speakers with integrated filters and amplifier electronics.

14 pre-configured routings allow every reasonable configuration from up to 4 different input signals to the 4 output channels.

Frequently used combinations of routings and 'LS-Blocks' can be saved along with further parameters (such as Gain / Delay / PEQ) in up to 64 set-ups.

Two-step limiter concept

Two limiters work in each of the 4 output channels. A quick reacting "peak limiter" limits the peak level and, thus, the cone excursion of the connected speakers is kept at non-critical levels.

A slow reacting 'RMS Limiter' reduces the level when there is a risk that the permissible average power will be exceeded, thus resulting in the voice coils overheating.

The pre-set values have been established in extensive series of tests. With excellent sound qualities, they provide an outstanding compromise with regard to the peak levels and protection of the speaker systems.

Automatic determination of gain using sense technology

The CD 44 calculates the gain of the connected amplifiers in real-time and automatically corrects the limiters' thresholds as soon as the gain of the connected amplifier should be changed (i.e. by using the input potentiometer or similar). Compared to conventional devices this results in a clearly improved reliability when adjusting the limiter thresholds.

Limiter reduction

The preset limiter thresholds can be reduced in fine increments for specific purposes. This function is advantageous when the connected speakers are to be subjected to a particularly long-lasting high load. In this case, the reduction of the limiter thresholds reduces the maximal thermal and mechanical stress, thus significantly extending the product life of the speakers.

Furthermore, these functions can also be used to limit the sound levels of the speakers.

The integrated limiters and the function 'Limiter Reduction' can also be used for speakers with integrated amplifier electronics. For this, the gain values of the utilised power amplifiers can be edited manually in the CD 44.

Operating with 'Shortcut' buttons

Four buttons with 'Shortcut' functions make it possible to directly jump to often-used functions without having to navigate through the menu. By pushing these buttons repeatedly, you access the functions of all input and output channels.

In doing so, the functions 'Gain', 'Delay', 'Filter' and 'PEQ' can be quickly and easily adjusted.

Additionally, the LEDs which are integrated into the respective buttons indicate if these functions have been changed as compared to the original settings.

31 Band One-Third Octave EQs

A separate 31 band one-third-octave EQ is assigned to each of the CD 44's four input channels. Up to 16 different EQ setups can be saved and administrated in an individual EQ setup library. These EQ setups can be loaded in addition to the setups.

5. Software and Firmware Update

If software and firmware updates are available, they can be found in the download area of the Kling & Freitag website www.kling-freitag.de.

Software and firmware updates are necessary if Kling & Freitag LS-Blocks are made available for new speakers or the device's range of function has been expanded. This ensures that the CD 44 will always be up-to-date and assured of a good future for speaker generations to come.

You receive the installation instructions when you execute the update.

5.1 Use of the CD 44-AutoUpdater

The CD 44-AutoUpdater allows you to keep all components of your CD 44 up-to-date. In addition to update your K&F software, the latest LS-Blocks will also be transferred to your hard drive, either automatically or manually, depending on the program setting. Once the process has completed, you can transfer the LS-Blocks to your CD 44 controller, as usual. This keeps your LS-Blocks up-to-date.

After installation, you can run the main program from the "Kling & Freitag" folder in the startmenu. If you are running the program for the first time, a start screen is shown. With the button of the start screen, you can set the update interval and your preferred language.

5.1.1 Determine update interval

The following possible update intervals and languages are available:

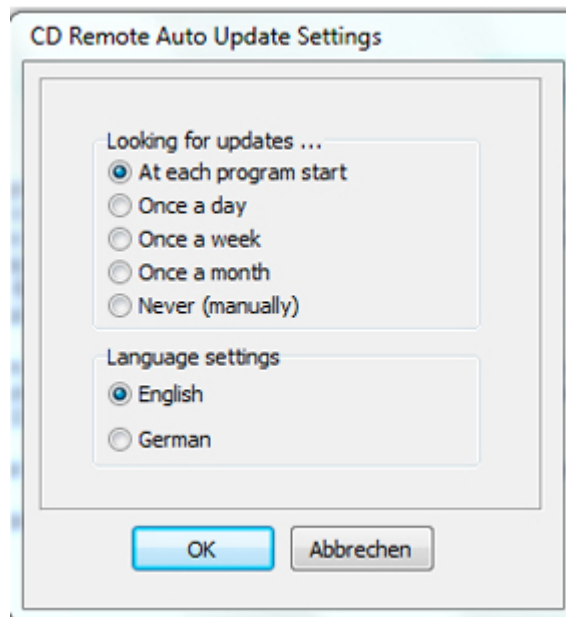

If you do not want to specify a time interval and select the option "never", you should start the update process manually from time to time.

We recommend that you adopt default interval "at each program start".

5.1.2 Update history

Before starting the update, ensure that your computer is connected to the Internet.

During the update, you may be prompted to log in as an administrator. In Windows 7, for example, you only need to confirm the displayed Administrator Note and the update is then completed without further system messages.

When the update starts, an update search and version synchronisation of the program and existing LS-Blocks with our company server will first run. The search result and version synchronisation will be shown in the information window.

If you have changed any files in the K&F system folder ("C:\Program Files (x86)\KlingFreitag\CD Remote\"), the folder will be renamed into an archiv folder and a new folder with the new updatefiles will be created.

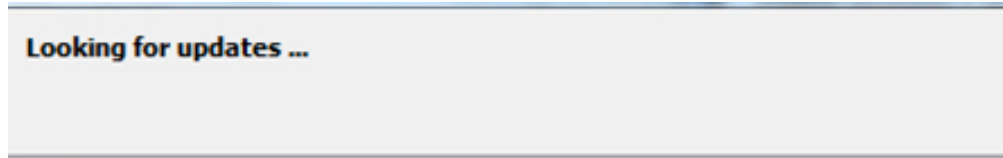

Update log file of the 16.05.2014 10:19:43

Download: CD Remote.exe

Download: CD Update.exe

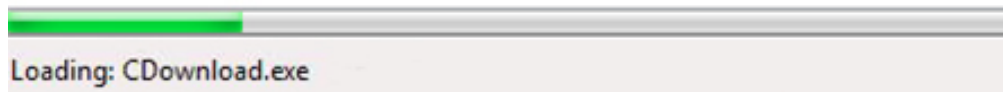

The actual update process only takes a few seconds in most cases. If comments on the new LS-Blocks are to be written, these are displayed in the Info window and stored in a log file.

If new LS-Blocks were copied to your hard drive, the Info window will show you where a log file was saved on your computer and under which name.

If the update finished successful you can transfer the new LS-Blocks to your CD 44 system controller and use the K&F software normally.

6. Connectors, Functions, Controls and Displays

6.1 Front

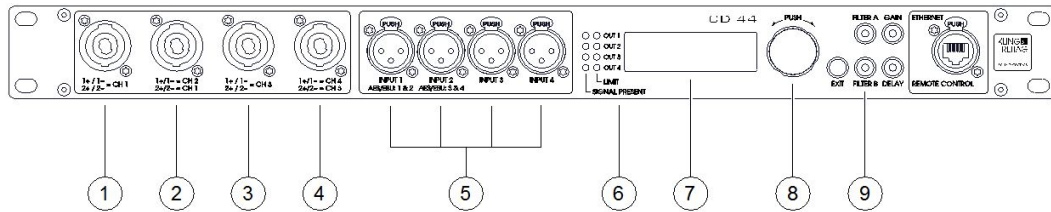

1 - 4: Speaker connectors (4x)

4-pin Speakon connectors. All Kling & Freitag speakers that are, by default, connected with 1+ / 1- can be plugged into these connectors.

Notice

Caution: The connectors with the position numbers 1 and 3 are connected differently than the connectors with the position numbers 2 and 4.

In some cases, mixing up the speaker channels can lead to destruction of the speakers (example: treble on bass output).

1. This output connector supplies the signal for the speaker channel 1. In this connector, the pin 1+ is bridged with 2+, the pin 1- with 2-. The signal for channel 1 is, therefore, applied to 1+ / 1- as well as 2+ / 2-.
2. This output connector transmits signals for 2 speaker channels:
The signal for the speaker channel 2 is applied to 1+ / 1-.
The signal for the speaker channel 1 is applied to 2+ / 2-.
3. This output connector supplies the signal for the speaker channel 3. On this connector, the pin 1+ is bridged with 2+ and pin 1- with 2-. The signal for channel 3 is, therefore, applied to 1+ / 1- as well as 2+ / 2-.
4. This output connector supplies signals for 2 speaker channels:
The signal for the speaker channel 4 is applied to 1+ / 1-.
The signal for the speaker channel 3 is applied to 2+ / 2-.

1 + 3: If you want to use the CD 44 to operate subwoofers whose 2 chassis are controlled by separate supply lines (ACCESS B5 and ACCESS B10), then you should use these connectors for these subwoofers in order to control the speakers via a common channel without an adapter (CH1 or CH3). For more information see configuration example on page 46.

2 + 4: You should use these connectors for ACCESS tops T5 and T9, Sequenza 10 N / W or NOMOS XLC, because these systems must be controlled using 2 channels.

In order to implement a one-cable system (control of a top and subwoofer via a 4-core supply cable), you must use these connectors, because the top and subwoofer must be controlled using 2 different channels.

5. **Signal input connectors: INPUT 1 through INPUT 4**, 3-pin XLR female connectors.

These signal input connectors can be used both for analogue and for digital signals, in accordance with the AES / EBU specifications. You must make the selection in the device about the type of signals it is being supplied with: digital or analogue. **Select the type of signal source before connecting the signals!**

Upon delivery, the controller is pre-programmed for the use of analogue input signals.

These inputs correspond to the connectors on the rear panel and are wired in parallel with them.



Caution

Do not assign the inputs on the front and rear panel simultaneously. This can lead to malfunction or damage of other appliances!

- **Operations with analogue input signals, settings: In » Input Patching » Analog (Default, Flipped or 1&2 Mix):** Pin configuration: 1 = ground / 2 = + / 3 = - . The LINE inputs are electronically balanced. The nominal input level is +6dBu (1.55Vrms). The maximum input level is +18dBu, that is, the peaks in the signal must not exceed +18dBu (6V).
- **Operations with digital input signals, setting: In » Input Patching » Digital (Default, Flipped or 1&2 Mix)**

The input connectors 'INPUT 3' and 'INPUT 4' are not used in this setup! Pin configuration: 1 = ground / 2 and 3 = digital signal. **To avoid unexpectedly high volume levels, reduce the controller's input gains to a value of approx. -40 dBu before supplying these connectors with a digital signal directly from an audio source, and then adjust the level to your needs! Adjust input gain at: <In » Input1> through <Input4 » Gain>**

6. SIGNAL PRESENT, LIMIT

- **SIGNAL PRESENT:** These LEDs light up green when a signal with a level higher than -45 dBu is present at the XLR output connectors on the rear of the unit (Out 1 through Out 4).
- **LIMIT:** The output level of the controller is limited. As a result, the controller avoids an output level of the power amplifiers which is too high for the connected speaker. These LEDs light up red as soon as the output level of the relevant channel comes under the influence of the controller's limiters. A gently engaging RMS limiter and a fast peak limiter limit the output of the power amplifiers virtually inaudibly to the maximum permitted level. If the red limiter LEDs light up frequently, the level of the input signal should be reduced on the signal source preferably (i.e. on the mixing console).

7. Display

To change the contrast, go to <Util » Display » Contrast>.

8. Knob

Turn the knob to navigate through the menus and adjust the values. Push the knob to confirm a selection, access the submenus, the command lines, and the settings.

9. EXIT button

You can confirm the chosen settings by pushing the EXIT button, and the menu returns to the next higher level.

10. FILTER A Button (Shortcut Button)

Pushing the FILTER A button allows you to directly access the freely adjustable parametric filters (PEQs) without having to navigate through the menu.

Up to four parametric filters (PEQs) are available for every active input channel.

If a filter is active (BYP = bypass in edit mode not active), the blue LED on the FILTER A button lights up.

For a detailed description see chapter 'Parametric Filters 'PEQ' + SEQ LShelv' on page 15.

11. FILTER B Button (Shortcut Button)

By pushing the FILTER B button, you can access pre-set speaker-specific filters, such as High-Boost, Cluster and Bass Boost, etc.

These filters cannot be adjusted by the user; they can only be switched on or off.

If one of these filters is active, the blue LED on the FILTER B button lights up. FILTER B

For further information see chapter 'Switchable, Speaker Specific Filters' beginning on page 21.

12. GAIN Button (Shortcut Button)

Pushing the GAIN button allows you to directly access the input and output gains without having to navigate through the menu. GAIN

After pushing the GAIN button, the first possible setting is for the signal input (input gains). If you push it repeatedly, you access the output gains. GAIN

If one of these gain values is not zero, the red LED on the GAIN button lights up. GAIN

For more information, see Chapter 'Input and Output Delays' on page 24.

13. REMOTE CONTROL

This RJ45 connector allows for you to connect the CD 44 to a computer or integrate it into a network in order to execute remote enquiries and remote control or to import software updates. The connection conforms to Ethernet standards. The IP address can be changed at <Util » IP Address>.

You can find the latest software versions on www.kling-freitag.de

6.2 Rear

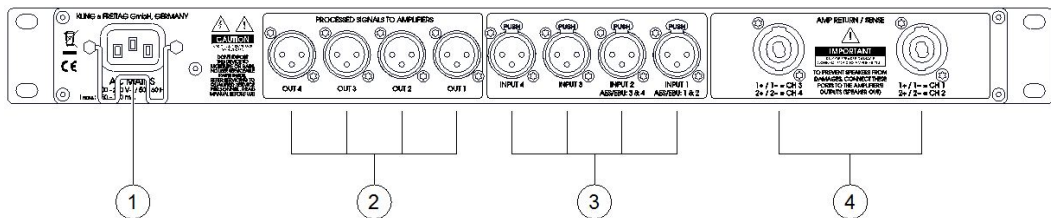

1. Power Supply Connector

IEC power socket 100 - 240 V~ / 50 - 60 Hz, I nominal: 150 - 100 mA.

Connect this socket to a mains outlet using the mains cable supplied with the controller. To avoid an unintentional loosening of the mains cable, the power supply connector is provided with a safety clamp. Flip the clamp over the connector of the mains cable after having plugged it into the power supply connector.

Pay attention to the stated mains voltage. Connection to an incorrect mains voltage may result in irreparable damage!

2. OUT 1 through OUT 4

3-pin XLR male connector, pin assignment: 1 = ground, 2 = +, 3 = -

These outputs deliver the line signal processed by the controller to the power amplifiers. Connect these outputs to the inputs of the power amplifiers.

3. Signal input connectors: INPUT 1 through INPUT 4, 3-pin XLR female connectors.

These connectors correspond to the connectors on the front and are wired in parallel with them. For a detailed description of the inputs see page 9.



Caution

Do not assign the inputs on the front and rear panel simultaneously. This can lead to malfunction or damage of other appliances!

4. AMP RETURN / SENSE

1 + / 1 - = CH 1	and	1 + / 1 - = CD 3
2 + / 2 - = CH 2		2 + / 2 - = CH 4

You must plug the amplified output signals of the power amplifiers into these connectors (speaker signal).

The amplified output signals which are connected here are required by the limiters in the controller (sense signal). The signal is routed to the Speakon connectors CH 1, CH 2, CH 3 and CH 4 on the front, so that the speakers can be connected.



Caution

If the connectors 'AMP RETURN / SENSE' are not connected to the power amplifiers, then there is a risk that the speakers will be ruined. Exception: When using the CD 44 with SP speakers, the AMP RETURN / SENSE inputs are not used, as the SP speakers are equipped with their own limiters. CD 44

7. Making Adjustments and Navigating Through the Menus

In this chapter, we will give a detailed description of how to make adjustments or to save or cancel changes and how to navigate through the menus.

7.1 The Use of the Shortcut Buttons

The shortcut buttons help you to make quick adjustments without having to navigate through the menu. We therefore recommend that you solely use the shortcut buttons and not the menu navigation when making adjustments to the parametric filters (PEQs), the input and output gains, as well as to the input and output delays.

Adjustments that are made using the shortcut buttons do not have to be confirmed by pushing the EXIT button. After approx. 10 seconds, the adjustments made to the device are confirmed automatically.

7.1.1 Parametric Filters 'PEQ' + SEQ LShelv (Filter A Button)

By pushing the FILTER A button, you access the parametric Filters (PEQ).

Using the menu navigation, the PEQs can be accessed at <In » PEQ » Filter 1> through <Filter 4>.

Up to 4 parametric filters per input channel serve to equalise the system, i.e. to adjust the speaker frequencies to the room conditions. They can also be used to eliminate the feedback during monitor uses. The PEQs are saved with the setup.

In the PEQs, the parameters for filter type, gain, frequency, and Q-factor can be adjusted.

If a filter is active (BYP = bypass in edit mode not active), the blue LED on the FILTER A button lights up.

If you change to another type of filter, the Q-factor automatically sets itself to a value of 0.707. This safeguards against unexpectedly high levels which might be caused by a Q-factor that is too high. When you have changed the type of filter, always make sure if a Q-factor of 0.707 meets your needs and correct it, if necessary.

Explanation of the filter types of the PEQ:

The parameter "Gain" is adjustable in steps of 0.1, from -96 to +24 dB (independent of the input and output gains). The parameter 'Gain' has no effect on the filter types 'LowP', 'HighP' and 'AP'.

The parameter "Freq" is adjustable in 1Hz steps, from 10Hz to 20kHz.

1. Bell = Bell Filter

This filter increases certain frequency ranges (positive gain) or attenuates them (negative gain).

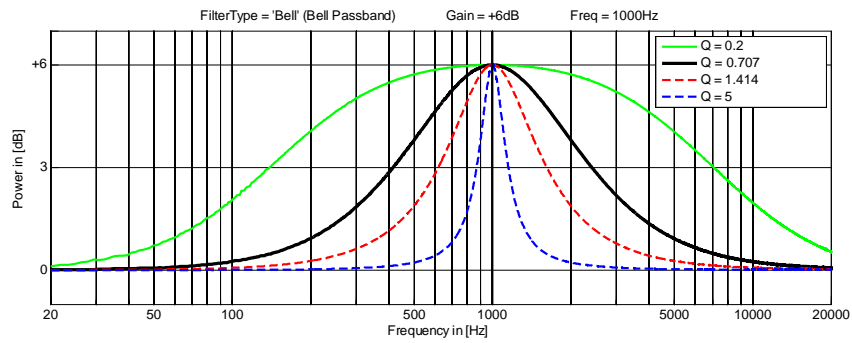

The gain determines the maximum or minimum level increase or attenuation of the filter (in the graph: increase of +6dB).

This 'bell' is logarithmically symmetrical relative to the selected frequency (in the example: 1000 Hz).

The Q-factor defines the quality of the filter. In doing so, it determines the width of the frequency range which is to be increased or attenuated. The higher the Q-factor, the narrower the frequency range. A lower Q-factor thus has a wider range.

"Q" is adjustable in steps of 0.001 from 0.2 to 20.

Typical Q-values and their bandwidth equivalent:

Bandwidth	Q factor
1/3 Oktave (third)	4.318
2/3 Oktave (two thirds)	2.145
1 octave	1.414
1 1/3	1.044
1 2/3	0.819
2	0.666
1/6 octave (whole step)	8.651

2. HShelv (high shelving filter)

3. LShelv = Low Shelving Filter

These filters increase (positive gain) or attenuate (negative gain) the frequencies below or above the selected frequency.

Below = LShelv

Above = HShelv

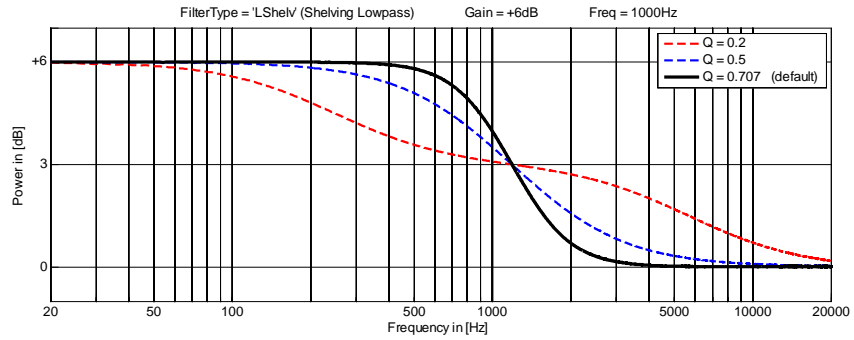

Low Shelving Filter

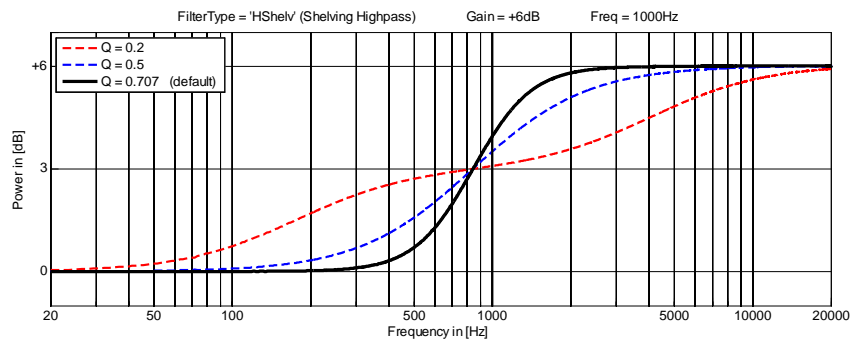

Above = HShelv

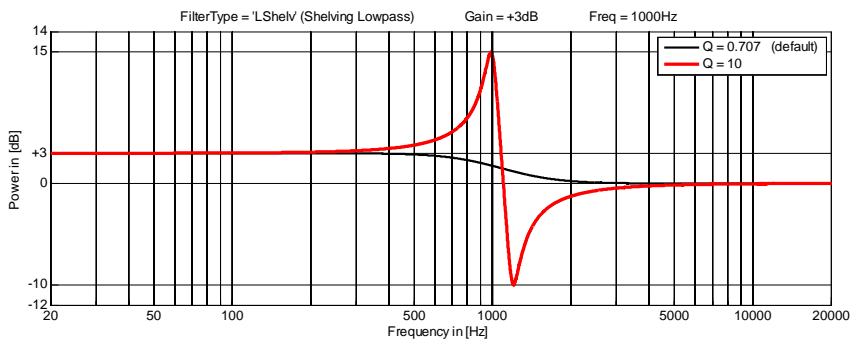

Low Shelving Filter, $Q > 0,707$

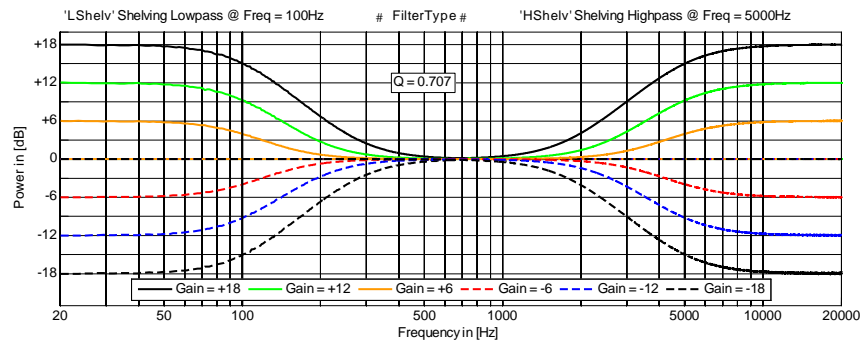

Different increases and attenuations:

Low Shelving Filter @ 100 Hz,

High Shelving Filter @ 5 kHz,

$$Q = 0,707$$

The Q-factor determines the slope of the filter.

Normally, shelving filters are used with a Q-factor of up to 0.707.

With Q-factors higher than 0.707, the selected frequency is increased and an area above this frequency range is attenuated correspondingly. The shelving filter is, thus, normally only used up to Q 0.707.

A Q higher than 0.707 may result in unwanted sound changes.

Q is adjustable in 0.001 steps from 0.2 to 20.

As soon as a Seq10 LS-Block is loaded into the controller, the corresponding input channel of the input filter 4 is set to SEQ LShelv. Furthermore, frequency, Q-factor and gain are limited to sensible levels for this use. It is necessary to set an LShelv for all tops in order to counteract the coupling of the arrayed low-mid speakers.

The LShelv is to be programmed IDENTICALLY for every input path of all tops.

SEQ LShelv setting for exemplary speaker arrays (default values):

In practice, depending on the geometry of the room and other application-specific factors, the actual values to be set may vary from the default values listed below. Therefore, the sound engineer may finely adjust the output gain using an additional parametric filter when setting the system.

The filter depth and the cut-off frequency of the low shelving filter depend on the amount of speakers. The larger the number of speakers

- the stronger the attenuation
- and the lower the cut-off frequency

The attenuation can be set from 0 to -14 dB, the cut-off frequency from 250 Hz – 1 kHz, Q from 0.5 – 0.707.

The following chart shows reference values for selecting the SEQ LShelv for all SEQUENZA 10 tops in each corresponding array:

Number of tops	GAIN	Freq	Q
1, - 6,	-4.5 dB	1 kHz	0.7
7 - 8	-7 dB	850 Hz	0.7
9 - 10	-9 dB	850 Hz	0.7
11 - 12	-8.5 dB	500 Hz	0.7
13 - 16	-11 dB	300 Hz	0.7
17 - 18	-11 dB	250 Hz	0.7
19 - 20	-12 dB	350 Hz	0.5
21 - 22	-13 Hz	250 Hz	0.5
23 - 24	-14 dB	250 Hz	0.5

You can create the SEQ LShelv settings by the software CD Remote automatically. Please specify the number of used tops. Refer the Software Starter Guide 'CD Remote'.

4. This example shows different high pass filters which are characterised by varying Q factors.

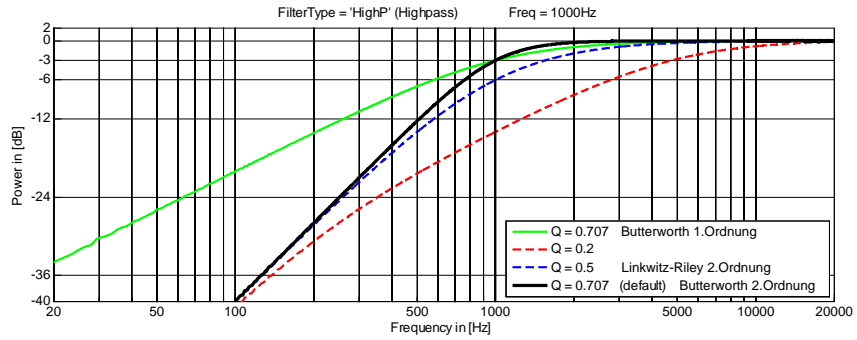

The resulting filter Q = 0.707 is a 2nd order Butterworth filter and causes attenuation of 3 dB at the cut-off frequency (-3dB @ 1000Hz). Below the cut-off frequency, there is an attenuation of 12 dB per octave (-12dB/octave).

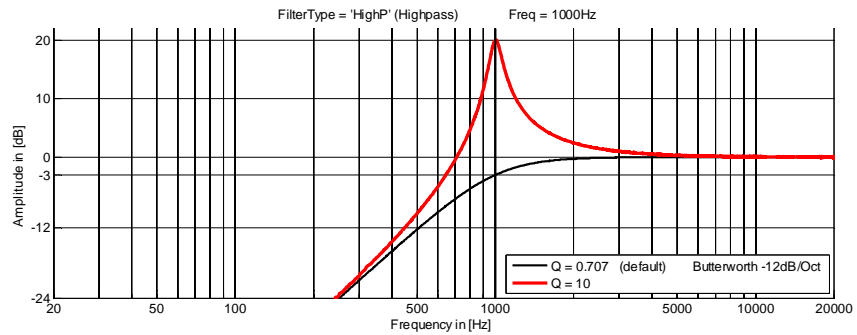

A Q higher than 1 causes a level increase at the crossover frequency.

You can choose between a high pass filter 1st or 2nd order. The Q of a 1st order high pass filter is always fixed. At a 2nd order high pass filter Q is adjustable in steps of 0.001 from 0.2 to 20.

The parameter 'Gain' has no effect with the high pass filters.

The following table illustrates how you can implement the common high and low pass filters and how many parametric filters you need to do so.

Type of filter	Slope	Number of necessary PEQs	Q high- / low pass filter 1	Q high- / low pass filter 2	Q high- / low pass filter 3	Q high / low-pass filter 3
Butterwor 1st ord.	6 dB/ oct.	1	0	-	-	-
Butterwor 2nd ord.	12 dB/ oct.	1	0.707	-	-	-
Linkwitz-Riley 2nd ord.	12 dB/ oct.	1	0.5	-	-	-
Butterwor 3rd ord.	18 dB/ oct.	2	1	0	-	-

Butterwor 4th ord.	24 dB/ oct.	2	1.307	0.541	-	-
Linkwitz- Riley 4th ord	24 dB/ oct.	2	0.707	0.707	-	-
Butterwor 5th ord.	30 dB/ oct.	3	1.618	0.618	0	-
Butterwor 6th ord.	36 dB/ oct.	3	1.932	0.707	0.518	-
Linkwitz- Riley 6th ord.	36 dB/ oct.	3	1	1	0.5	-
Butterwor 7th ord.	42 dB/ oct.	4	2.247	0.802	0.555	0
Butterwor 8th ord.	48 dB/ oct.	4	2.563	0.9	0.601	0.51
Linkwitz- Riley 8th ord.	48 dB/ oct.	4	1.307	1.307	0.541	0.541

5. LowP = Low Pass Filter

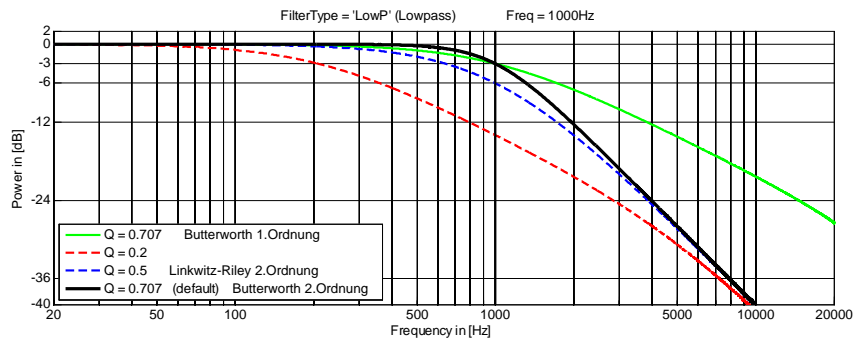

This example shows various low pass filters at 1000Hz, which are characterised by different Q-factors.

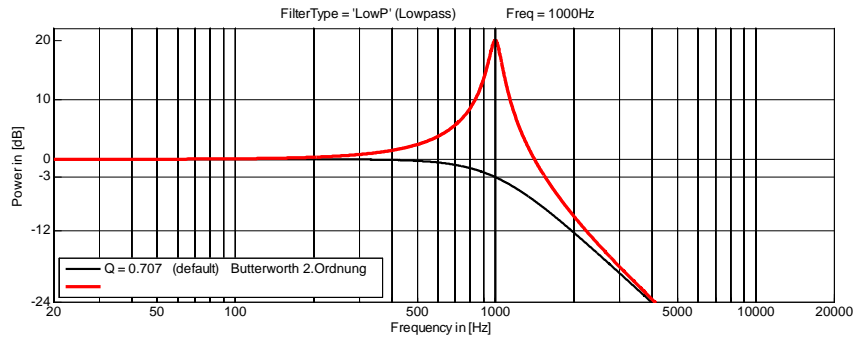

The resulting filter with $Q = 0.707$ is a 2nd order Butterworth filter and causes an attenuation of 3dB at the cut-off frequency (-3dB @ 1000Hz). Above the cut-off frequency, there is an at-attenuation of 12dB per octave (-12dB / octave).

A Q higher than 1 causes a level increase at the crossover frequency.

You can choose between a high pass filter 1st or 2nd order. The Q of a 1st order high pass filter is always fixed. At a 2nd order high pass filter Q is adjustable in steps of 0.001 from 0.2 to 20.

The parameter 'Gain' has no effect with the low pass filters.



Tip

In the section HighP = High Pass Filter, you will find a table for high and low pass filters that shows examples of how to implement common low pass filters and how many parametric filters are required to do so.

6. AP = All Pass Filter

In doing this, it does not cause any increase or attenuation of frequency levels.

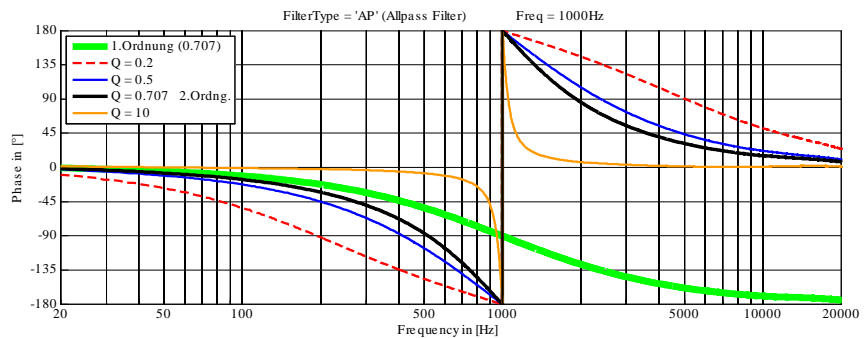

Der Q-Faktor bestimmt die Steilheit des Phasensprungs. Je höher, desto steiler.

For a 1st order all pass filter, 0 must be selected for the Q. Values higher than 0 produce a 2nd order all pass filter.

7.1.2 Switchable, Speaker Specific Filters

By pushing the Filter B button, you access the preset speaker-specific filters. You cannot access this filter setup via the menu navigation, but only by using the shortcut button. These filters cannot be set by the user – they can only be switched on or off and are a part of the LS-Blocks. Depending on which speaker was selected for which output, there are various filters available. The speakers are assigned as follows: FILTER B

<Out » Output1> through <Output4 » Select LS-Block>

Push the Filter B button until you access the filter which you wish to switch on or off. FILTER B

If one of these filters is active, the blue LED on the FILTER B button lights up. FILTER B
This illustration shows a cluster filter which is assigned to a speaker at Out1.

The following table shows which filters are available for the relevant LS-Blocks:

Speaker (LS-Blocks)	Filter 1	Filter 2
SONA 6	Presence	High Boost
CA-Series and Line 212	Cluster	High Boost
SW-Series, all B5 and B10	Cluster	-
B10 SubLow	Bass Boost	-
ACCESS High	-	High Boost
ACCESS Mid (Clus / Sngl)	-	-
ACCESS B5	-	-
ACCESS B10 (all versions)	Bass Boost	-
Seq10LF / (HF and FR)	Straight	High Boost
Seq10LF / (FR and LCut)	Straight	High Boost
Seq10LF / (FR and LCut)	Straight	-
Seq10B (all versions)	-	-
NomXLC (all versions)	-	-

Explanations for the speaker-specific filters:

- **Presence:** Mid boost. To achieve sound compatibility with the SONA 5 without the CD 44, switch on this filter along with the High Boost Filter. CD 44
- **High Boost SONA 5:** slight increase using a Shelving Filter. To achieve sound compatibility with the SONA 5 without the CD 44, switch on this filter along with the Presence filter. CD 44
- **High Boost:** To compensate high-range attenuation over long distances for tops.
- **Sequenza 10 N / W:** The high boost filter should only be switched on for speakers whose main beam is directed towards audience sections that are approx. 40 m or further away. Normally, this only applies to a few of the upper speakers.
- **Cluster:** To compensate undesired frequency additions in the low-mid range for monitor and cluster usage (cluster = several speakers placed directly next to one another). Switch on the Cluster Filter for tops if you wish to operate several tops (cluster) next to one another or if you place the top on the floor as a monitor. This reduces the frequency additions in the low/mid range that result from clustering the speakers (with one another or on the floor).
If you operate several tops aligned next to one another (cluster), then there is an addition of certain frequencies that can interfere with the sound results. This frequency addition is compensated by the cluster filter. If these clusters are positioned on a subwoofer, then the phasing between the tops and the subwoofer can be improved when both ways run through the same filter, in other words: when the cluster filter is also switched on for the subwoofer.
- **Bass Boost:** To boost the bass for usages with the ACCESS B10 speakers.

- **Straight (Sequenza 10 N / W only):** The straight filter serves to harmonise the balance of the upper-mid range between shorter and larger listening distances. It is preferably used for speakers whose angle to the other speakers is 0°, 1° or 2. The Straight-Filter must be switched in both paths of the speaker, so in the Seq10LF / HF (FR or LCut) and the Seq10LF (FR or LCut) to 'ON'.

7.1.3 Input and Output Gains (Gain Button)

Pushing the GAIN button allows you to directly access the input and output gains without having to navigate through the menu. GAIN

After pushing the GAIN button, the first possible setting is for the signal input (input gains). If you push it repeatedly, you access the output gains. GAIN

If one of these gain values is not zero, the red LED on the GAIN button lights up. GAIN

How high a gain can actually be set depends on, among other things, if and how high an output gain is already preset in an LS-Block. The output gains saved in the LS-Block are neither visible nor adjustable. Depending on the LS-Block, these output gains have values between 0dB and +5.3 dB. It is, therefore, possible that the user can set the gains accordingly lower than the otherwise possible +24 dB. We generally advise against selecting such high gain values.

1. The Input Gains regulate the level for the line signal input (INPUT 1 through INPUT 4).

Using the menu navigation, the input gains can be accessed at <In » Input1> through <Input4 » Gain>.

Depending on the output gain and the previously used gain in the LS-Block, the input gains can be set between -96 dB and +24. The sum of the input gain, the output gain, and the LS-Block's gain can not exceed +24 dB.

Adjustments to the input gains may be necessary if, for example, the limiter LEDs light up often. In this case, the input gains can be reduced.

If the input signal is too weak, use the input gains to increase it.

You can find an overview of the input gain settings on a prompt, subsequently referred to as InfoWindow 1. This InfoWindow 1 initially appears approx. 7 seconds **after turning on** the device, or when you have not used it for approx. 7 seconds, or after you have pushed the EXIT button several times. EXIT

You can find more detailed information about this in the chapter 'InfoWindow: Display of Basic Settings' on page 24.

2. The **Output Gains** regulate the level of the individual signal outputs (OUT 1 through OUT 4).

You can access the output gains at <Out » Output1> through <Output4 » Gain> in the menu.

Depending on the input gain and the gain previously used in the LS-Block, the output gains can be set up between -96 dB and +24. The sum of the input gain, the output gain, and the LS-Block's gain can not exceed +24 dB.

The output gains are used for, for example:

- level adjustments for different zones of sound coverage.

- level adjustments between top speakers and subwoofers. When the number of arrayed subwoofers is doubled, the level increases by up to + 6 dB (+3 dB efficiency and +3 dB by doubling the power amplifier output). Due to their directivity, the level of the top speakers does not increase correspondingly.

Furthermore, because of missing floor reflections, a flown subwoofer can be several decibels quieter than a subwoofer which is standing on the floor.

The output gain functions offer the possibility to adjust this level balance, depending on the configuration and use.

According to the room geometry, the actual level balance which needs to be adjusted may differ from the aforementioned reference values. It is, therefore, always necessary for a sound technician to carry through fine adjustments of the output gains when the system is set up.

7.1.4 Input and Output Delays (Delay Button)

After pushing the DELAY button, the first settings you access are for the input delays. Pushing the button repeatedly will give you access to the output delays.

The units for the delays can be converted from milliseconds (ms) to metres (m) at <Util » Units>. The unit 'Metre' is based on a sound velocity of 343 m/s at 20°C.

If one of these delay values is not zero, the red LED on the DELAY button lights up.

1. Use the **Input Delays** to create delay lines.

Delay lines are speakers which are set up behind one another. The delay times of the speakers' sound propagation is compensated using delays.

The purpose of delay lines is to ensure that the sound from the speakers near the stage reaches the listeners in the back of the audience simultaneously (preferably) with the sound from the speakers in the rear audience area.

You can separately adjust the delays of up to four input channels, with every channel having a total available delay of 200 ms or 68.6 m. Because a delay of 0.02 ms is already set up in the LS-Block ACCESS High, the available delay time when using this LS-Block is reduced accordingly by this amount.

2. Use the **Output Delays** to compensate differences in delay time of the positioned speakers, for example from flown tops to standing subwoofers, stage edge speakers to the main system, etc. You can separately adjust a total of 4 output channels.

Out 1 and Out 2 share 20 ms or 6.86 m delay time.

Out 3 and Out 4 also share 20 ms or 6.86 m delay time.

These values decrease if there is already a delay set in an LS-Block.

If you select a delay of 5 ms or 1.715 m for Out 1, then there are another 15 ms or 5.145 m available for Out 2. The same also applies for Out 3 and Out 4. The value stated next to 'Avl =' indicates how much delay time is still available.

7.2 InfoWindow: Display of Basic Settings

A window initially appears, subsequently referred to as InfoWindow 1, approx. 7 seconds **after turning on** the device, or when you have not used it for approx. 7 seconds, or after you have pushed the EXIT button several times. If you are currently in InfoWindow 1, and you then turn the knob to the right (clockwise), you will access InfoWindow 2. EXIT

This illustration shows InfoWindow 1 for the loaded setup 'Example 5':

```

Example 5*      CD44
G1:  0.0      G3:  0.0
G2:  0.0      G4:  0.0
4in4out      ANA
  
```

The InfoWindow 1 shows information about the following basic settings:

- **1st line:** Name of the loaded setup, here: Example 5. If there is an asterisk next to the setup name, this means that changes have been made to the setup that have not been saved yet.
- **2nd and 3rd line:** Settings of the Input Gains 1-4 (Depending on routing, 1 to 4 adjustable gains).
- **4th line:** type of routing, here: '4in4out' and the selected input sources (ANA = analogue inputs, AES = digital inputs)

This illustration shows InfoWindow 2 for the loaded setup 'Example 1' with additionally activated filters:



The **InfoWindow 2** shows which speaker block (LS-Block) is assigned to which output (1-4).

Furthermore, it also gives you information about the status of the selectable speaker-specific filters (ON / OFF). The left box stands for Filter 1, the right box for Filter 2. If a box is checked off, then the corresponding filter is active. If there is no box, then the filter for the corresponding speaker (LS-Block) is not available. You can find further information about the filters in chapter 'Switchable, Speaker Specific Filters' beginning on page 21.

7.3 Main Menu

If you are in InfoWindow 1 or 2, you can return to the main menu by pushing the knob.

The main menu consists of the following main menu items: **Setup, In, Out** and **Util**.

Turn the knob to make the blinking cursor (position indicator) move horizontally to the corresponding main menu item.

If the cursor is at a certain menu item, the corresponding submenu appears. In the following illustration, the cursor is initially at the main menu item Setup. If you turn the knob some more, then the cursor moves on to the further main menu items **In, Out**, and **Util**.

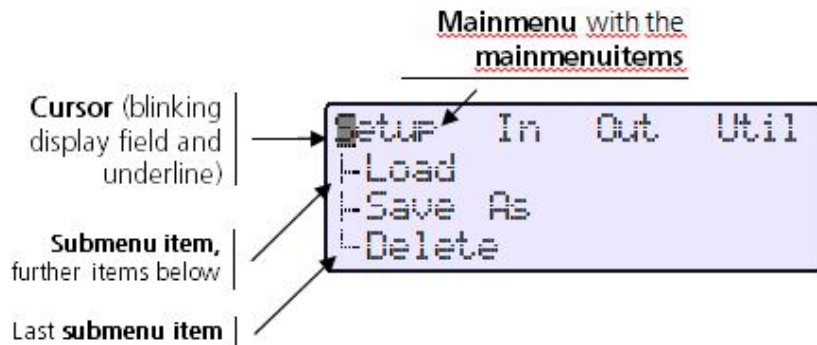

Push the knob to access the submenu where the cursor currently is located. In the following example, the cursor has been moved to the main menu item Util which was selected by pushing the knob.

7.4 Submenu

Turn the knob to make the blinking cursor (position indicator) move horizontally to the corresponding main menu item. If the cursor is at a certain menu item, the corresponding submenu appears. In the following illustration, the cursor is initially at the main menu item Setup. If you turn the knob some more, then the cursor moves on to the further main menu items In, Out, and Util.



Push the knob to access the submenu where the cursor currently is located. In the following example, the cursor has been moved to the main menu item Util which was selected by pushing the knob.

7.5 Setups in editing mode

All settings are executed in real time.

There are three different editing modes:

1. Editing mode with one editing line
2. Editing mode with several editing lines
3. Selection Mode with selection lines

7.5.1 Editing mode with one editing line

In order to follow the aforementioned example, we will show the editing mode with one editing line: the editing mode **Contrast** of the submenu item **Display**.

Changing Parameters

The underline marks if you can change the parameters in increments of 1 or 10. (In other editing modes, further increments are also possible). In the illustration below, the underline is below the zero, this means, the ones digit will be changed.

You can change the parameters in increments of one by turning the knob f.

If you wish to **change the parameters in increments of 10**, then **push the knob once** so that the cursor blinks. In this case it is blinking in the ones place. Turn the knob to the left so that the underline is under the tens place (the cursor is no longer blinking). Then you can change the parameters in increments of 10 by turning the knob.

Confirm changes

To confirm the changes made in the current editing mode, push the EXIT button 2x. The screen returns to the preceding submenu. The settings are kept until a new setup is loaded or until the settings are changed. Changes that have been made in fewer than 10 seconds before the device is shut down are lost after it is turned off. Please wait at least 10 seconds after having made final changes before turning off the controller. EXIT

To permanently store changes in a setup, save the setup at: <Setup » Save As>.

The following changes are not saved with a setup and are, therefore, maintained even after a setup has been loaded: InSelect, EQ 31-Band, Display, IP-Address, Units.

Undo (cancel changes)

To undo the changes made in the editing mode, turn the knob while the cursor is blinking (push the EXIT button 1x) to the left until the position indicator (arrow) points to the undo symbol. Then push the knob. The entries are cancelled and the screen returns to the preceding submenu. EXIT

Example of a display in the editing mode with one editing line:

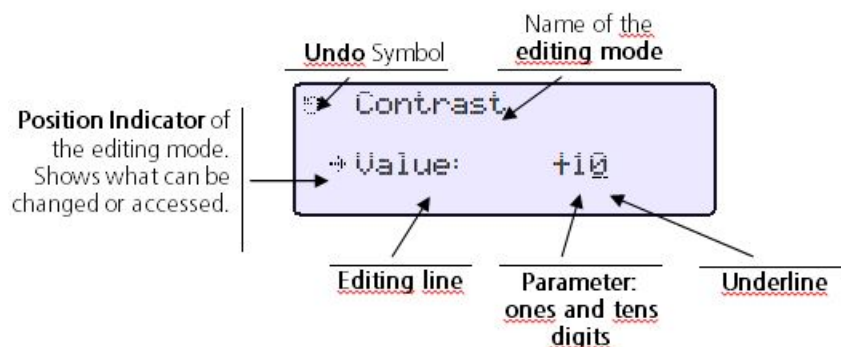

7.5.2 Editing mode with several editing lines

The following example will familiarise you with the menu navigation. You better access the PEQs using the shortcut button. Please read important notes beginning on page 15.

Changing Parameters

In the illustration below, you are at the following menu position:

<In » Input1> through <Input4 » PEQ » Filter 1> through <Filter 4>:

Select the line that is to be edited by turning the knob. This line is marked by the arrow. After you push the knob, the underline marks which position of the parameters you are changing while turning the knob.

In the illustration, the underline is under the 10ths place of the Gain parameters (here 00.0). You can change the 10ths place of the parameters by turning the knob. In order to change the ones or the tens places, push the knob and move the blinking cursor to the place which you wish to change. If you push the knob again, the underline indicates the position which you can change by turning the knob. To confirm the entry, push the EXIT button. EXIT

Confirm Changes

To confirm the changed settings in the current editing mode, push the EXIT button 2x, and you will return to the previous submenu. The settings are kept until a new setup has been loaded or until the settings have been changed. Changes which have been made less than 10 seconds before the device is shut down are lost after it is turned off. Please wait at least 10 seconds after having made final changes before turning off the controller. EXIT

To permanently store changes in a setup, save the setup at: <Setup » Save As>.

The following changes are not saved with a setup and are, therefore, maintained even after a setup has been loaded: InSelect, EQ 31-Band, Display, IP-Address, Units.

Undo (cancel changes)

To **undo** the changes made in the editing mode, turn the knob to the left until the arrow points to the undo symbol. Then push the knob. The entries are cancelled and the screen returns to the preceding submenu (here: **Input1**).

Help

To get help with the different editing modes, turn the knob to the left until the arrow points to the help symbol (question mark). You can find the appropriate help topic by pushing the knob. Pushing it again returns you to the editing mode. **There is not a help text for every editing mode.**

Example of a display in the editing mode with several editing lines:

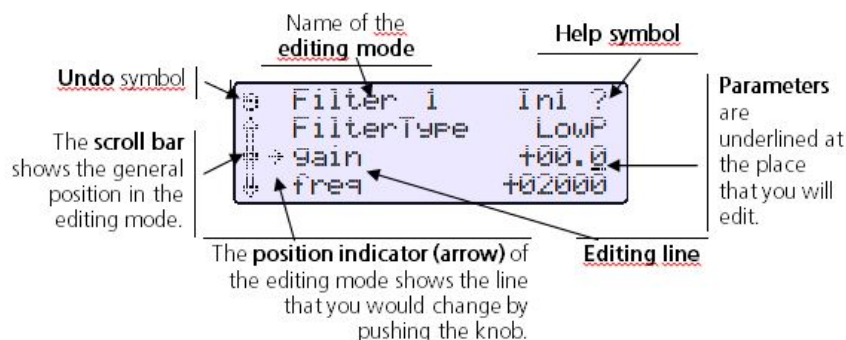

7.5.3 Editing Mode with Selection Lines

In the illustration below, you are at the following menu position:

Util » Routing

Move the position indicator (arrow) to the line that you want to select by turning the knob. Push the knob to choose the selected line. The selection is made and you return to the preceding submenu (here: **Util**).

Confirm selection

To confirm the changed selection in the current editing mode, push the knob and you will return to the previous submenu. The selection is kept until a new setup has been loaded or until the selection has been changed. Changes which are made less than 10 seconds before the device is shut down are lost after it has been turned off. Please wait at least 10 seconds after having made the final selection before turning off the controller.

To permanently store the selection, save the setup at: <Setup » Save As>.

The following changes are not saved with a setup and are, therefore, maintained even after a setup has been loaded: InSelect, EQ 31-Band, Display, IP-Address, Units.

Example of a display in the editing mode with selection lines:

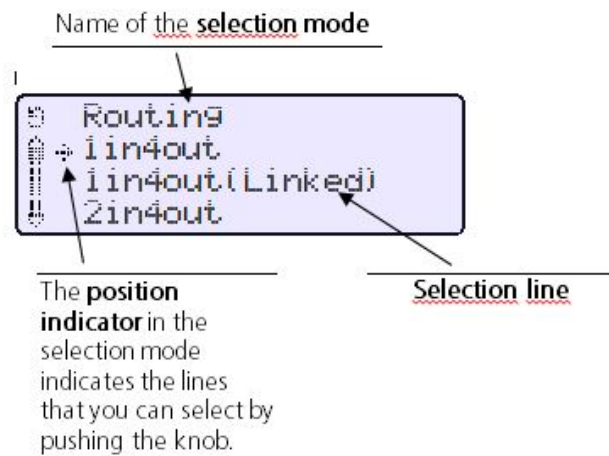

7.5.4 Menu Tree of the CD 44 and Explanation of the Functions

Overview of the CD 44 menu tree:

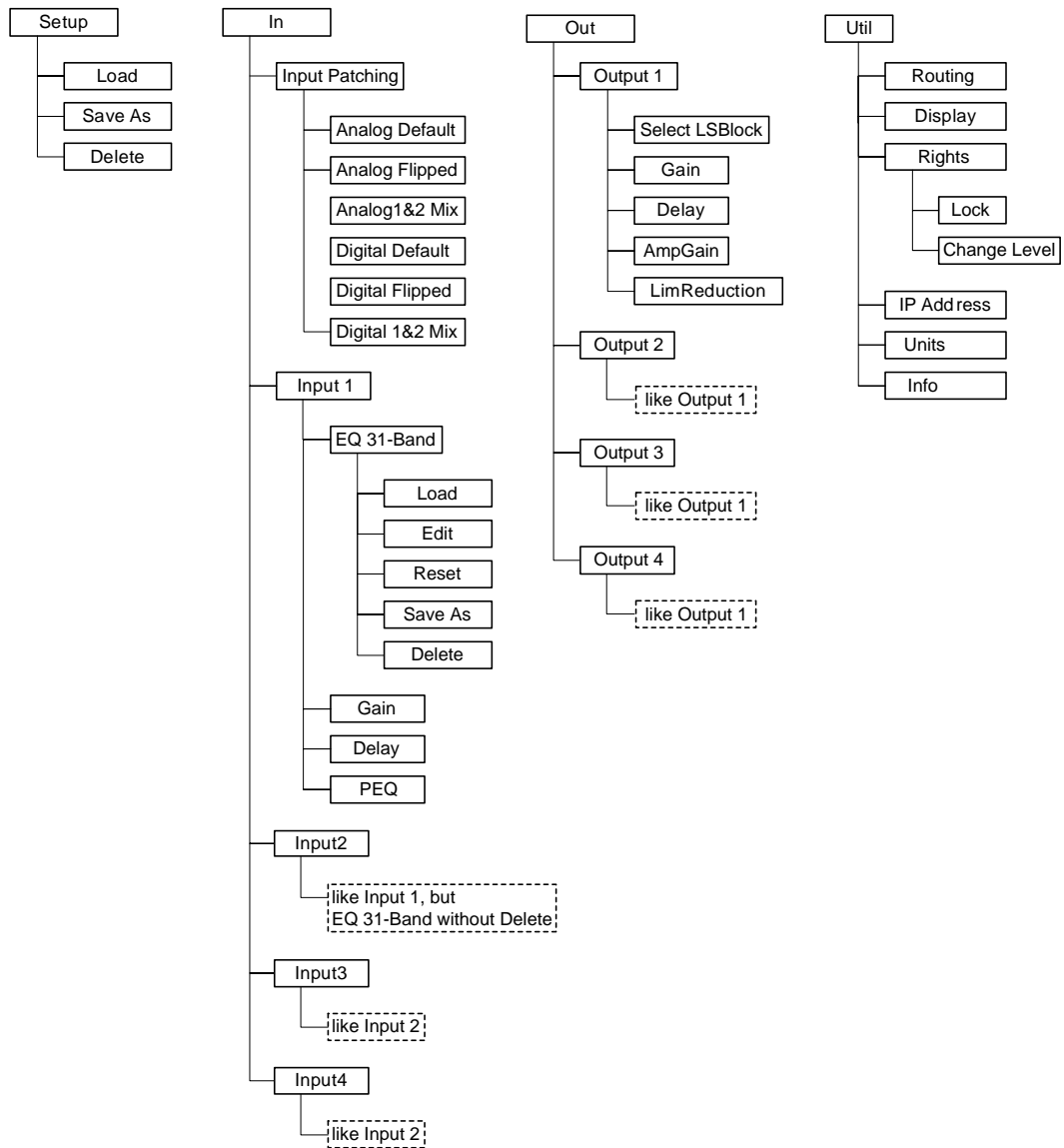

The dotted-line menu items are not available in user mode.

Detailed instructions about the authorisation modes in chapter 'Functions of the Menu Items under 'Util'' beginning on page 40.

7.5.5 Functions of the Menu Item 'Setup'

The submenu items <Load, Save As>, and <Delete> carry out their functions within the named setups. You can save up to 64 setups. To save changed settings permanently, you must save the setup in the main menu <Setup » Save As>!

Approx. 10 seconds after the last change, the CD 44 saves the current status in its memory. This ensures that the changes that you make, even if they are not saved in a setup, are not lost when the device is switched off or if there is a power outage. Please wait at least 10 seconds before turning off the controller to make sure that all settings can be restored after switching the controller on again, including the loading, saving and deleting of setups.

Changes which were not saved in a setup are lost after a new setup has been loaded <(Setup » Load)>.

- <In » Input1> through <Input4 » EQ 31-Band>
- <Util » Units> (zum Umschalten der Einheiten der Delays von m in ms),
- <Util » IP Adress> (for network connections)

- <Util » Display> (display contrast)

The settings in the following functions do, however, remain after a new setup has been loaded:

- <In » Input1> through <Input4 » EQ 31-Band>
- <Util » Units> (zum Umschalten der Einheiten der Delays von m in ms),
- <Util » IP Adress> (for network connections)
- <Util » Display> (display contrast)

1. Save As

Save under a new name

- To save a setup (changed or unchanged) under a new name, select <Setup » Save As> by turning and pushing the knob.
- Select <new>.
- The name of the current setup appears.
- Position the arrow under the letters that you wish to change.
- Turn the knob and select the letter or number by turning the knob.
- When the desired letter or number is shown, verify the entry by pushing the knob.
- The arrow automatically jumps to the next letter or number.

Continue as described above until you have written the desired name.

By pushing the EXIT button, you save the setup under the name you have defined. EXIT

When you have selected <new>, it is not possible to save under a previously existing name. The attempt will be answered with the error message Name exists.

Overwriting the currently selected setup

To save a changed setup under the same name, activate <Setup » Save As> (turn and push the knob).

The arrow is on the name of the setup that you have just changed. By pushing the knob, you can save your changes.

Overwriting a previously existing setup (not the setup currently selected)

To save a setup under another previously existing name, activate <Setup » Save As> (turn and push the knob).

The arrow is on the name of the current setup. By turning the knob, you can select another previously existing name and save your setup by pushing the knob.

2. Load

With <Setup » Load> you can call up the saved setups. When loading a new setup, all 31-band EQs (<In » Input1> through <Input4 » EQ 31-Band>) are set to Bypass (switched off), but all other settings are maintained.

3. Delete

With <Setup » Delete>, you delete the saved setups. The currently loaded setup cannot be deleted. Select a setup by turning then pushing the knob. Confirm the deletion by pushing the knob again, or cancel it by pushing the Exit button.

7.5.6 Functions of the Menu Items under 'In'

In the following description the input connectors are named with capital letters (INPUT 1 through INPUT 4). The input sections in the routings are named with bold letters (Input1 through Input4).

The AES/EBU channels are described with left and right (INPUT 1 left/right; INPUT 2 left/right).

The possible settings for the input signals can be set under the menu item 'In'. Depending on which routing you have selected, up to 4 inputs are available for settings (Input1 through Input4):

In Input Patching, you can choose if the CD 44 will be supplied with analogue or digital signals. Furthermore, there is the possibility here to create a mono sum or to exchange input channels. See graphic on next page.

1. **In » Input Patching:**

In Input Patching, you can choose if the CD 44 will be supplied with analogue or digital signals. Furthermore, there is the possibility here to create a mono sum or to exchange input channels. See graphic on next page.

2. **In » Input Patching » Analog Default**

The controller is supplied with analogue input signals.

The nominal input level is +6dBu (1.55Vrms).

The maximum input level is +18dBu, that is, the signal peaks must not exceed +18dBu (6V).

3. **In » Input Patching » Analog Flipped**

Corresponds to the setting: **In » Input Patching » Analog Default**, but INPUT 1 is exchanged with INPUT 2, and INPUT 3 with INPUT 4.

4. **In » Input Patching » Analog 1&2 Mix**

With this setting, the mono sum out of INPUT1 and INPUT2 is created immediately behind the physical inputs. In routings having just one input (i.e. 1 in 4 out), the second input is activated with this setting to create the mono sum of a two channels.

5. **In » Input Patching » Digital Default**

The input connectors INPUT 3 and INPUT 4 are not used in this mode!

The input connectors INPUT 3 and INPUT 4 are not used in this mode!

Notice

Make the adjustment <In » Input Patching » Digital Default> before connecting the digital signal!

To avoid unexpectedly high volume levels, reduce the controller's input gains to a value of approx. -40 dB before you supply these connectors with a digital signal directly from an audio source, and then adjust the level to your needs!

Adjust input gain at: <In » Input1> through <Input4 » Gain>

The digital signals which are connected here may have a resolution of 16, 18, 20, or 24 bits and a sampling rate of 32 kHz, 44.1 kHz, 48 kHz, 88.2 kHz, 96 kHz, 176.4 kHz, or 192 kHz.

When using the AES / EBU input, in addition to the system delay of 0.5 ms, a further delay arises from the sample rate converter: With a sample rate of 44.1 kHz = approx. 2.4 ms. With a sample rate 48 kHz = approx. 2.2 ms. With a sample rate 88.2 kHz = approx. 1.5 ms. With a sample rate 96 kHz = approx. 1.4 ms. Further instructions in dealing with the data transmission process AES / EBU can be found in chapter 'Instructions for AES / EBU Data Transmission' on page 71.

6. **In » Input Patching » Digital Flipped**

Corresponds to the setting: <In » Input Patching » Digital Default>, but the signals have a crossover routing. So what was previously the left signal becomes the right, and vice versa. Exchanging the pins 2 and 3 has no effect.

7. **In » Input Patching » Digital 1&2 Mix**

With this setting, the mono sum out of AES/EBU INPUT1 left and right is created immediately behind the physical inputs. In routings having just one input (i.e. 1 in 4 out), left and right are activated with this setting to create the mono sum of a stereo signal.

8. **Illustration of the different Input Patchings**

Definition:

The routings 1 in 4 out (linked) and 2 in 4 out (linked) are not shown subsequently. With these routings, linked means that channel 1 is linked to channel 3, and channel 2 to channel 4 in the output section (Out). With 2 in 4 out (linked), channel 1 is also linked to channel 2 in the input section (but not EQ 31-Band). You must only adjust the settings one time per channel pair.

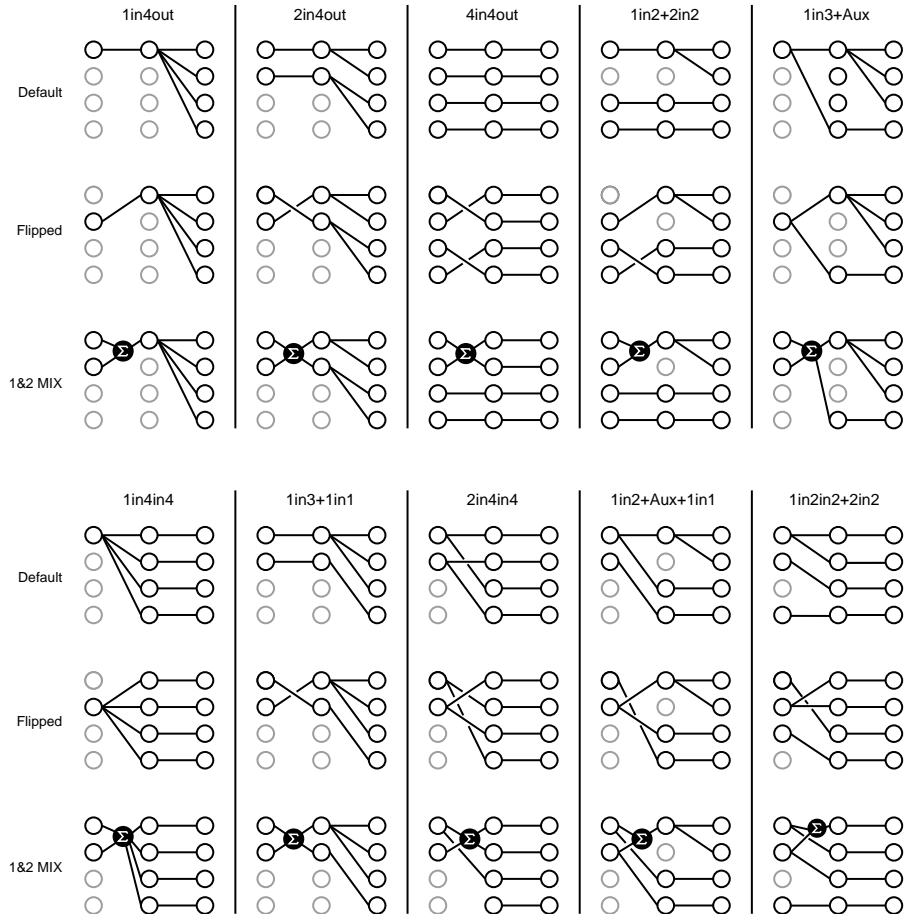

<In » Input1> through <Input4 » EQ 31-Band>

This is a graphic one-third-octave band equalizer with 31 bands from 20 Hz - 20 kHz. It serves as a system equalizer, i.e. to adjust the speaker frequencies to the room conditions. It can also be used to eliminate feedback during monitor use.

The EQ settings are not saved in the set-up, but in a separate setups. The adjustments are not saved in the Setup, but rather in separate EQ setups (Pay attention to the different meanings of Setup / EQ Setup!). Up to 16 EQ setups can be saved. This makes it possible to access and use a saved EQ setup within the different setups.

When loading a new setup, all EQs are set to 'Bypass' (switched off). To switch the EQs on again, select:

<In » Input1> through <Input4 » EQ 31-Band » Edit » Bypass On>.

All other settings are maintained.

Submenus in EQ 31-Band:

With the submenus Load, Edit, Reset, Save As and Delete you can – irrespective of the setup – access, edit, reset, save, and delete EQ setups.

With this, you can load different EQs in addition to a setup (i.e. same use at different locations).

Load

Used to load named EQ setups.

Select the desired setup (position indicator) by turning and pushing the knob.

Edit

Used to edit named EQ-Setups.

Here you can edit the 31 bands of the one-third-octave band equalizer.

Furthermore, you can set the EQ to Bypass . With the setting Bypass, the EQ is by-passed and thus does not influence the signal. This function is, for example, advisable when evaluating the before/after effect when editing the EQs.

Reset

Used to return all settings in the current EQ setup back to zero. This is advisable if, for example, you are going to create a new EQ setting.

Save As

Used to save the changes in named EQ setups.

- To save a new EQ setup activate <In » Input> through <Input4 » EQ 31-Band » Save As> (turn and push the knob). Select <new> by turning the knob, push the knob twice, and select the first letter or number by turning the knob. If the desired letter or number is shown, then verify the entry by pushing the knob. The position indicator automatically jumps to the next letter or number. Continue as described above until you have written the desired name.
By pushing the EXIT button, you will save the setup under the name you have defined.
- To save changes in a previously existing EQ setting, activate <In » Input1> through <Input4 » EQ 31-Band » Save As>. The position indicator is on the EQ setting that you just edited. Pushing the knob saves the change.

Delete

This function is used to delete named EQ settings. It is accessible at <In » Input1 » EQ 31-Band only>.

<In » Input1> through <Input4 » EQ 31-Band>

Gain (input)

See chapter 'Input and Output Gains' on page 23.

Delay (input)

See chapter 'Input and Output Delays' on page 24.

<PEQ » Filter 1> through <Filter 4> (easier to access with 'Filter A Button'). EXIT

See chapter 'Parametric Filters PEQ' + 'SEQ LShelv' on page 15.

7.5.7 Functions of the Menu Items under 'Out'

This is where you can make the possible adjustments for the output signals. Four outputs are available (<Out » Output1> through <Output 4>):

1. Select LS-Block

This is the position where the controller is informed which Kling & Freitag speaker is connected to which output. The controller then loads the parameters for the speaker-specific:

- adjustment of the volume level (gains) for the optimal connection of the K&F subwoofers to all listed K&F tops.
- filters for optimising the frequency response and the feedback prevention.

- limiter settings for operating and malfunction safety.
- high and low pass filters for multiway speaker systems (tops with subwoofers).
- phase correction between tops and subwoofers in multiway systems.
- bass boost for full-range systems (tops).



A wrong assignment of the LS-Blocks may ruin the loudspeakers.

Table with the currently available LS-Blocks, their ranges of use, and their recommended combination with other LS-Block.

Name LS-Block	Application
AccessB10 120Hz*	ACCESS B10 combined with ACCESS T5 / T9 (without ACCESS B5)
AccessB10 55Hz*	ACCESS B10 combined with ACCESS T5 / T9 and flown ACCESS B5
AccessB10 60Hz*	ACCESS B10 combined with ACCESS T5 / T9 and standing ACCESS B5
AccessB5*	ACCESS B5 combined with ACCESS T5/T9
ACCESS High	High frequency channel for the ACCESS T5 / T9
Access Mid Clus	Mid frequency channel for ACCESS T5 / T9, for clustered flown or standing systems.
Access Mid Sngl	Mid frequency channel for ACCESS T5 / T9, for single standing or flown systems
B10 SubLow	ACCESS B10 combined with speakers of the CA and Line Series and with subwoofer ACCESS B5 or subwoofers of the SW Series. ACCESS B10 combined with flown speakers of the CA and Line Series in full-range mode (FR).
B10*	ACCESS B10 combined with speakers of the CA and Line Series
B5*	ACCESS B5 combined with speakers of the CA and Line Series
CA... or Line 212...LCut	CA... oder Line 212...FR
CA... oder Line 212...FR	Top speaker in full-range mode (without combined subwoofers)
Flat	Special application, e. g. for editing or forwarding of line signals or the using of ...

* Use the LS-Blocks B10 and B5 solely for usages without ACCESS top speakers (i.e. Line 212 or speakers from the CA Series) and the LS-Blocks ACCESS B10, ACCESS B10 55Hz, ACCESS B10 60Hz and ACCESS B5 only when ACCESS top speakers are being used.

Name LS-Block	Application
---------------	-------------

Sona 5	top speaker in full-range mode and combined with the subwoofer
SE... (all)	Operation of a SW series subwoofer

SEQUENZA 10:

Name LS-Block	Application	Combination with LS-Block
SW215E Seq 60Hz	SW215E combined with SEQUENZA 10 N / W in full range operations (FR)	SEQ 10...FR
Seq10...FR Seq10LF/HF FR in combination with the LS-Block Seq10LF FR only!	SEQUENZA 10 use in full range mode.	SW215E SEQ 60Hz AccessB10 60Hz
Seq10...LCut LS-Block Seq10LF/HF LCut in combination with the LS-Block Seq10LF LCut only	SEQUENZA a 10 for maximum level usages: In this operating mode, the cut-off frequency of the Sequenza 10 N / W System is raised to relieve the subwoofers.	SW...(all) AccessB10 120Hz AccessB5. Depending on mounting or rigging location of the systems, the tops or subwoofers must be adjusted with delays to align the phasing of the systems to one another.
Seq10B	SEQUENZA 10 B in standard mode	Seq10...LCut, all other K&F top speakers: ...LCut and LS-Block Seq10B... with activated Filter B
Seq10B C-F	SEQUENZA 10 B in normal mode as Cardioid Front, front emitting	
Seq10B C-R	SEQUENZA 10 B in normal mode as Cardioid Rear, rear emitting	
Seq10B HC-F	SEQUENZA 10 B in normal mode as Hypercardioid Front, front emitting	
Seq10B HC-R	SEQUENZA 10 B in normal mode as hypercardioid rear, emitting to the back	
Seq10B 60Hz	SEQUENZA 10B in sub-bass mode	
Seq10B C-F60Hz	SEQUENZA 10 B in sub-bass mode as	Seq10...FR, all other K&F top speakers:

	Cardioid Front, front emitting	...FR and LS-Bock Seq10B... with activated Filter B
Seq10B C-R60Hz	SEQUENZA 10 B in sub-bass mode as Cardioid Rear, rear emitting	
Seq10B HC-F60Hz	SEQUENZA 10 B in sub-bass mode as Hypercardioid Front, front emitting	
Seq10B HC-R60Hz	SEQUENZA 10 B in sub-bass mode as hypercardioid rear, emitting to the back	

NOMOS XLC:

Name LS-Block	Application	Combination with LS-Block
NomXLC C-F	NOMOS XLC front speakers in normal mode as Cardioid	Seq10...LCut, all other K&F top speakers: ...LCut and LS-Bock Seq10B... with activated Filter B
NomXLC C-R	NOMOS XLC rear speaker in normal mode as Cardioid	
NomXLC HC-F	NOMOS XLC front speakers in normal mode as Hypercardioid	
NomXLC HC-R	NOMOS XLC rear speaker in normal mode as Hypercardioid	
NomXLC C-F60Hz	NOMOS XLC front speakers in sub-bass mode as Cardioid	Seq10...FR, all other K&F top speakers: ...FR and LS-Bock Seq10B... with activated Filter B
NomXLC C-R60Hz	NomXLC C-R60Hz	
NomXLC HC-F60Hz	NOMOS XLC front speaker in sub-bass mode as Hypercardioid	
NomXLC HC-R60Hz	NOMOS XLC rear speaker in sub-bass mode as Hypercardioid	

Gravis 8, Gravis 15:

Name LS-Block	Application	Combination with LS-Block
---------------	-------------	---------------------------

Gra8W-FR	Gravis 8W in full-range mode	-
Gra8W-LCut	Gravis 8W im LowCut Betrieb	all K&F Subwoofer
Gra15W-FR	Gravis 15W in full-range mode	-
Gra15W-LCut	Gravis 15W in low-cut mode	all K&F Subwoofer
Gra15N-FR	Gravis 15N in full-range mode	-
Gra15N-LCut	Gravis 15N in low-cut mode	all K&F Subwoofer

Nomos LS2, Nomos XLS, Nomos LT, Nomos XLT

Name LS-Block	Application	Combination with LS-Block
NomLS2 / NomLT / NomXLS / NomXLT	Nomos LS2 / Nomos LT / Nomos XLS / Nomos XLT im Normalbetrieb	all K&F loudspeaker
NomLS2 60Hz / NomLT 60Hz / NomXLS 60Hz / NomXLT 60Hz	Nomos LS2 / Nomos LT / Nomos XLS / Nomos XLT in sub-bass mode to support subwoofers in normal mode	all K&F loudspeaker
NomLS2 C-F / NomsLT C-F / NomXLS C-F / NomXLT C-F	Nomos LS2 / Nomos LT / Nomos XLS / Nomos XLT in normal mode as cardioid front, emitting to the front	all K&F loudspeaker
NomLS2 C-R / NomLT C-R / NomXLS C-R / NomXLT C-R	Nomos LS2 / Nomos LT / Nomos XLS / Nomos XLT in normal mode as cardioid rear, emitting to the back	all K&F loudspeaker
NomLS2 C-F60Hz / NomLT C-F60Hz / NomXLS C-F60Hz / NomXLT C-F60Hz	Nomos LS2 / Nomos LT / Nomos XLS / Nomos XLT in sub-bass mode as cardioid front, emitting to the front	all K&F loudspeaker
NomLS2 C-R60Hz / NomLT C-R60Hz / NomXLS C-R60Hz / NomXLT C-R60Hz	Nomos LS2 / Nomos LT / Nomos XLS / Nomos XLT in sub-bass mode	all K&F loudspeaker

	as cardioid rear, emitting to the back	
NomLS2 HC-F / NomLT HC-F / NomXLS HC-F / NomXLT HC-F	Nomos LS2 / Nomos LT / Nomos XLS / Nomos XLT in normal mode as hypercardioid front, emitting to the front	all K&F loudspeaker
NomLS2 HC-R / NomLT HC-R / NomXLS HC-R / NomXLT HC-R	Nomos LS2 / Nomos LT / Nomos XLS / Nomos XLT in normal mode as hypercardioid rear, emitting to the back	all K&F loudspeaker
NomLS2 HC-F60Hz / NomLT HC-F60Hz / NomXLS HC-F60Hz/ NomXLT HC-F60Hz	Nomos LS2 / Nomos LT / Nomos XLS / Nomos XLT in sub-bass mode as hypercardioid front, emitting to the front	all K&F loudspeaker
NomLS2 HC-R60Hz / NomLT HC-R60Hz / NomXLS HC-R60Hz / NomXLT HC-R60Hz	Nomos LS2 / Nomos LT / Nomos XLS / Nomos XLT in sub-bass mode as hypercardioid rear, emitting to the back	all K&F loudspeaker

Sequenza 5:

Name LS-Block	Application	Combination with LS-Block
S5W FR	Sequenza 5 in full- range mode	-
S5W LCut	Sequenza 5 in low- cut mode	all K&F Subwoofer
S5B	Sequenza 5B in normal mode	all K&F loudspeaker

2. Select <LS-Block » Flat>**Notice**

The LS-Block 'Flat' is a distinctive feature. It is intended for special uses such as processing or transmitting line signals, or using third party products or Kling & Freitag speakers where no LS-Block is available. In this LS-Block, all filters are switched off, and there is also no subsonic filter intended! It is still possible, though, to equalise signals with the help of the PEQs and the EQ 31 band.

When using speakers with the LS-Block 'Flat', the limiter must be set at <Out » Output1> through <Output 4 » LimReduction> based on the power ratings (W) of the speakers. You can find the power ratings of the speakers in the information provided by the speaker manufacturer (no liability for misrepresentation). With the following diagram, you can match the power specifications from the speaker manufacturer with the value for LimReduction that we recommend. We, therefore, recommend initially setting the LimReduction lower than recommended, and then carefully approaching the correct setting for the speaker.

The LS-Block 'Flat' is preset for 500W RMS @ 8 Ohm and 2000W Peak @ 8 Ohm.

Selected values for LimReduction, depending on the power ratings [W] of the speakers:

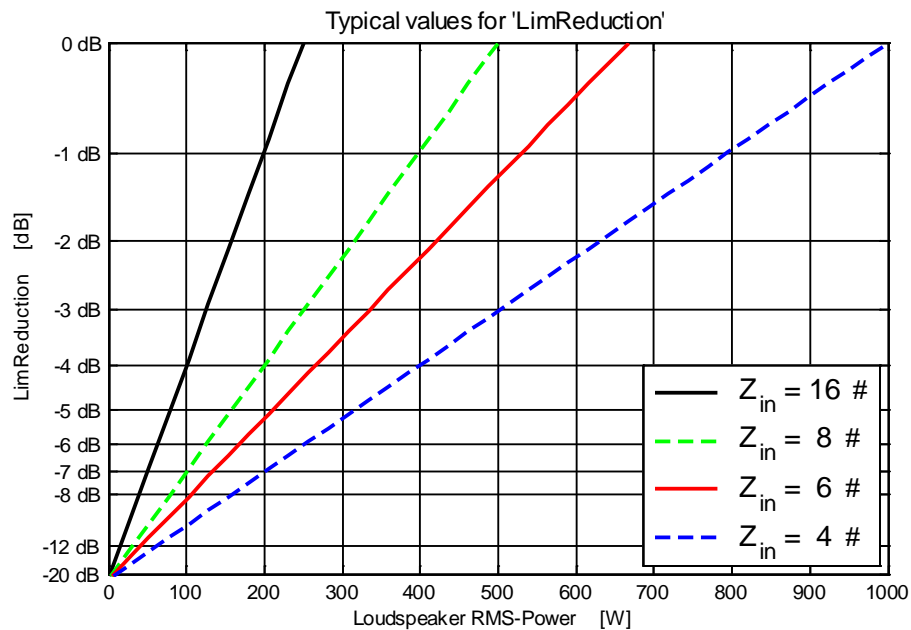

$$\text{Formel: LimReduction [dB]} = 10 \times \log_{10} \left(\frac{Z_{LS} [\Omega]}{8 \Omega} \times \frac{P_{RMS} [W]}{500 W} \right)$$

3. Gain (output)

See chapter 'Input and Output Gains' on page 23.

4. Delay (output)

See chapter 'Input and Output Delays' on page 24.

5. AmpGain

This is where the CD 44 shows the determined amplifier gain of the power amplifiers connected to the SENSE / RETURN connectors. After switching off the unit the settings always stay at the last plausibly determined value. As soon as a signal that can be analysed by the controller is applied to the Sense connectors, the controller determines the gain of the connected power amplifier. This value helps the controller to automatically adjust the limiter threshold. The controller continually checks this value and re-adjusts the limiter thresholds automatically, for example, when the gain of the power amplifier is changed manually.

- Amp1 for power amplifier channel at CH1
- Amp2 for power amplifier channel at CH2
- Amp3 for power amplifier channel at CH3
- Amp4 for power amplifier channel at CH4



Caution

If you do not use the connectors 'AMP RETURN / SENSE', there is imminent danger that the speakers could be destroyed. Exception: When operating the CD 44 with SP speakers, the AMP RETURN / SENSE inputs are not used, since the SP speakers are equipped with their own limiters. Further information in chapter 'SP Speakers on the CD 44' on page 65.

6. LimReduction

The limiters have been set during manufacturing so that they provide optimal operating safety and a wide dynamic range when used with adequately sized power amplifiers.

- If power amplifiers are used that are too small, the limiter threshold can be decreased by up to 20 dB so that the power amplifier does not begin to clip.
- For events where a reduction of the sound emissions is legally required, you can adjust the limiter so that the maximum permitted sound level is observed.
- Rental companies can set the limiter lower to protect their speakers from overloads caused by untrained personnel. For example: long-lasting techno events where the speakers can be pushed to their limits.

7.5.7.1 9.6.4 Functions of the Menu Items under 'Util'

For general settings of the CD 44.

Util » Routing

This is where you can call up the pre-configured routings in the Controller CD 44.

The routings determine how one or several input signals can be linked to one another and to the outputs, and which route the signals take. By calling up the routings saved in the CD 44, you have the possibility to configure the controller to meet the needs of your application.

Familiarise yourself with the routings in order to optimally use the functions such as EQ 31-Band and the long input delays. You can find a detailed explanation under Routings with Examples of Use and Connecting Diagrams on page 35.

Display

Here, you can adjust the contrast for the display.

Rights

The controller differentiates between three different authorization modes which called **Master, User, and Lock Mode**.

The device is supplied in the authorization mode **Master**.

Lock

The controller differentiates between three different authorization modes which we will, at this point, call User, Master, and Lock Mode.

If you would like to unlock the controller, enter your Master or User password at <Util » Rights » Change Level>.

Change Level

To legitimate yourself as a master or user, you must enter the appropriate password at <Util » Rights » Change Level>.

Setting the User password

In the delivery status, the User Mode password is user (note lower case!)

If you set the User password, the user has limited rights. This mode is appropriate when you, for example, lend the device and do not want basic changes or adjustments to be made which could compromise the operating safety.

- **Setup** The user may not load, save or delete any setups.
- **Out** The user may not make any changes for Select LS-Block, AmpGain and LimReduction.
- **Util:** The user may not change the 'Routing'.

Setting the Master password

In the delivery status, the Master Mode password is master ((note lower case!))

If you set the Master password, the user may make any changes except for giving out passwords.

Changing the User and Master password

To change the passwords for the user and master modes, enter the administrator password at <Util » Rights » Change Level>. The Admin Mode password is delivered with the controller in the form of a sticker. We recommend that the owner of the controller changes the user and master passwords before others use it. This ensures that no settings are made by unauthorised persons, which could result in the malfunction or damage of speakers. Please keep the password in a safe place to which unauthorised persons have no access. If this password should get lost, you, as the owner, can request the password at Kling & Freitag after stating the serial number.

IP Address

If you connect the CD 44 to a computer or a network via an Ethernet connection, this is where the communication address of the CD 44 is set. If you want to connect more than one CD 44 to the same network, the IP addresses of the controllers have to be different.

The changed IP address becomes effective only after you disconnect the unit from the power supply and restart it.

Notice

Units

The changed IP address becomes effective only after you disconnect the unit from the power supply and restart it.

Info

This is where you can find out the controller's serial number and which version of the software it uses.

8. Routings with Examples of Use and Connecting Diagrams

The usage examples which are mentioned here are saved as preset setups in the controller upon delivery with the names Example1 through Example 14.

When using with ACCESS speakers, we generally recommend using a connector panel from the K&F CP Series. If you do not have this connector panel, you can also connect the ACCESS speaker directly to the controller with the help of this example.

The pre-configured setups can be accessed at <Setup » Load>.

The routings saved in the controller can be accessed at: <Util » Routing>.

The routings determine how one or several input signals can be linked to one another and to the outputs, and which route the signals take. By calling up the routings saved in the CD 44, you have the possibility to configure the controller to meet the needs of your application.

In the following examples, we will show you the possible routing schemes with corresponding usage examples, including the connecting diagrams for speakers, CD 44, and power amplifiers. The examples only show a very small extract of the range of possible uses. We recommend that you study the routing schemes so that you can choose the correct routing for your application. CD 44

The examples given here – 'Example 1' through 'Example 11' as well as 'Example 13' and 'Example 14' – are based on analogue input signals with the input setting:

<In » Input Patching » Analog Default>.

'Example 12' refers to analogue input signals with the setting:

<In » Input Patching » Analog.1&2 Mix>.

For more information see Chapter 'Functions of the Menu Items under 'In'' on page 30.

8.1 'Rack Unit' Connecting Diagram for 1 CD 44 and 2 Amplifiers

All connecting diagrams and setup examples 1-12 and setup example 14 (not example 13, see K&F SystemRack) shown in this manual are based on the following standard diagram for one Controller CD 44 with two power amplifiers, subsequently referred to as 'Rack Unit'. CD 44

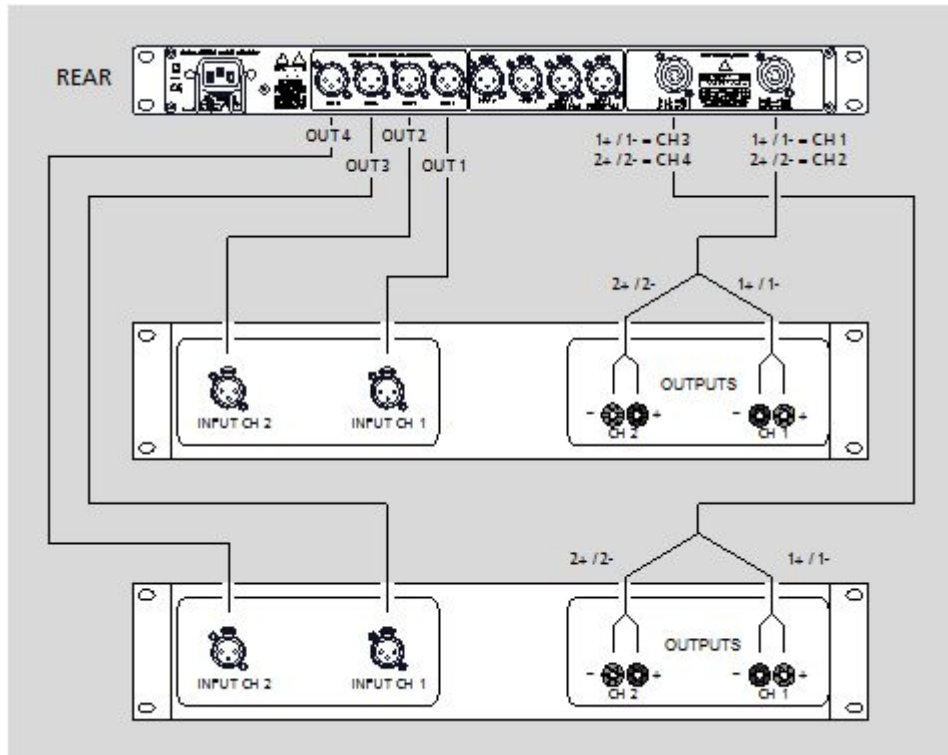

This 'Rack Unit' is designed for two power amplifiers of the same power ratings.

If you want to use power amplifiers with different specifications in a rack, be sure to wire the rack according to your requirements. Pay special attention to the assignment of the speaker output output connectors.

8.2 K&F 'System Rack' Connecting Diagram

Especially for use with the Sequenza 10 systems on tour, Kling & Freitag recommends setting up K&F system racks with one of each of the following:

K&F controller CD 44 / K&F connector panel CP 4 / power amplifier LAB GRUPPEN FP 10000Q

This system rack is also recommendable for a variety of other uses with Kling & Freitag systems.

You will find an example of use at Setup Example 13.

Notice

When using the Sequenza 10 N / W Systems without the Connector Panel CP 4, the channels for the LS-Blocks Seq10LF/HF (FR or LCut) and LS-Blocks Seq10LF (FR or LCut) in the CD 44 must be exchanged with one another! Apparent when you compare setup Example 13 with setup Example 14.

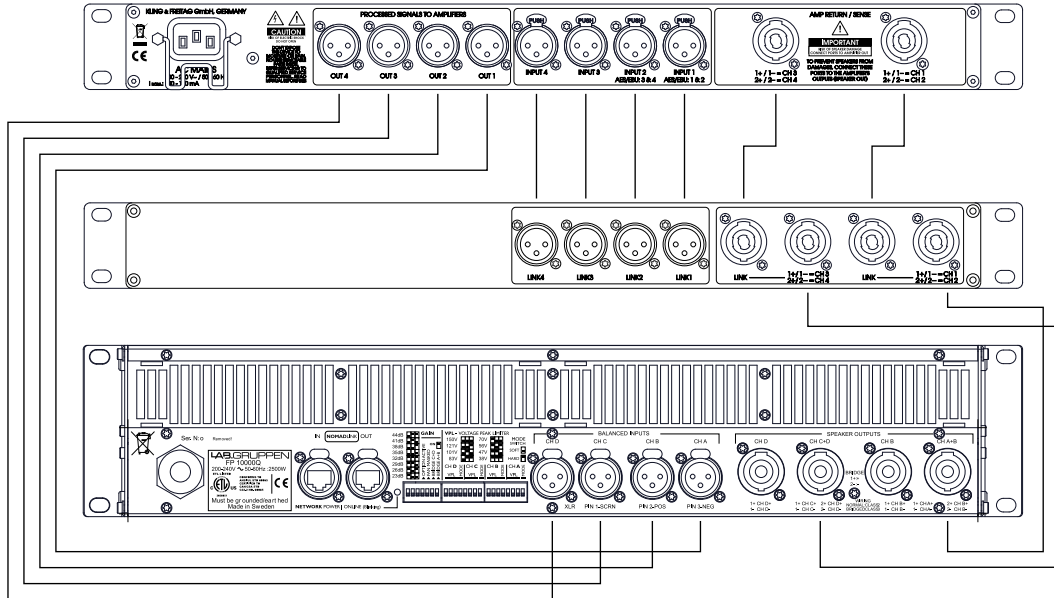

8.3 Routing '1 in 4 out' / Setup 'Example 1'

8.3.1 Block Diagram, 'Example 1'

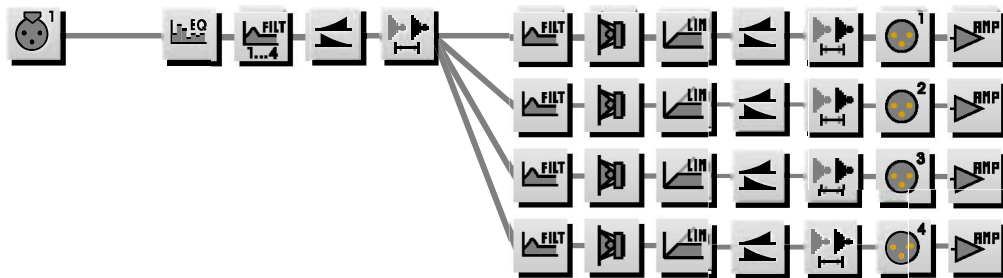

8.3.2 Setup 'Example 1', T5 / T9 with B10 on 2 Channels

Routing '1 in 4 out'

The tops ACCESS T5 / T9 should not be flown without using the subwoofer ACCESS B5. We, therefore, recommend that when the ACCESS T5 / T9 is combined with the ACCESS B10 without ACCESS B5, the top must always be placed on the ACCESS B10.

If the ACCESS T5 or T9 is used with EP-5 connectors, we recommend making and using an adapter cable from Speakon to EP-5.

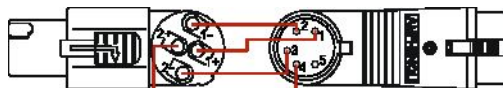

The current versions of the subwoofer ACCESS B5 and ACCESS B10 have a Speakon connector that is assigned to 1+/1- for both chassis. For these versions, you do not need the following adapter! If you want to connect a 1+/1- assigned ACCESS bass, then connect the ACCESS subwoofer like other 1+/1- assigned K&F subwoofers (see relevant examples).

If you use an ACCESS B10 with EP-5 connectors (the same applies to ACCESS B5), we recommend making and using an adapter cable from Speakon to EP-5. This adapter may only be used if you connect the B10 to a Speakon connector of the CD 44 that has only one connected channel. An example where the ACCESS B10 is connected to a CD 44 Speakon connector that is connected on two channels is shown on page 54.

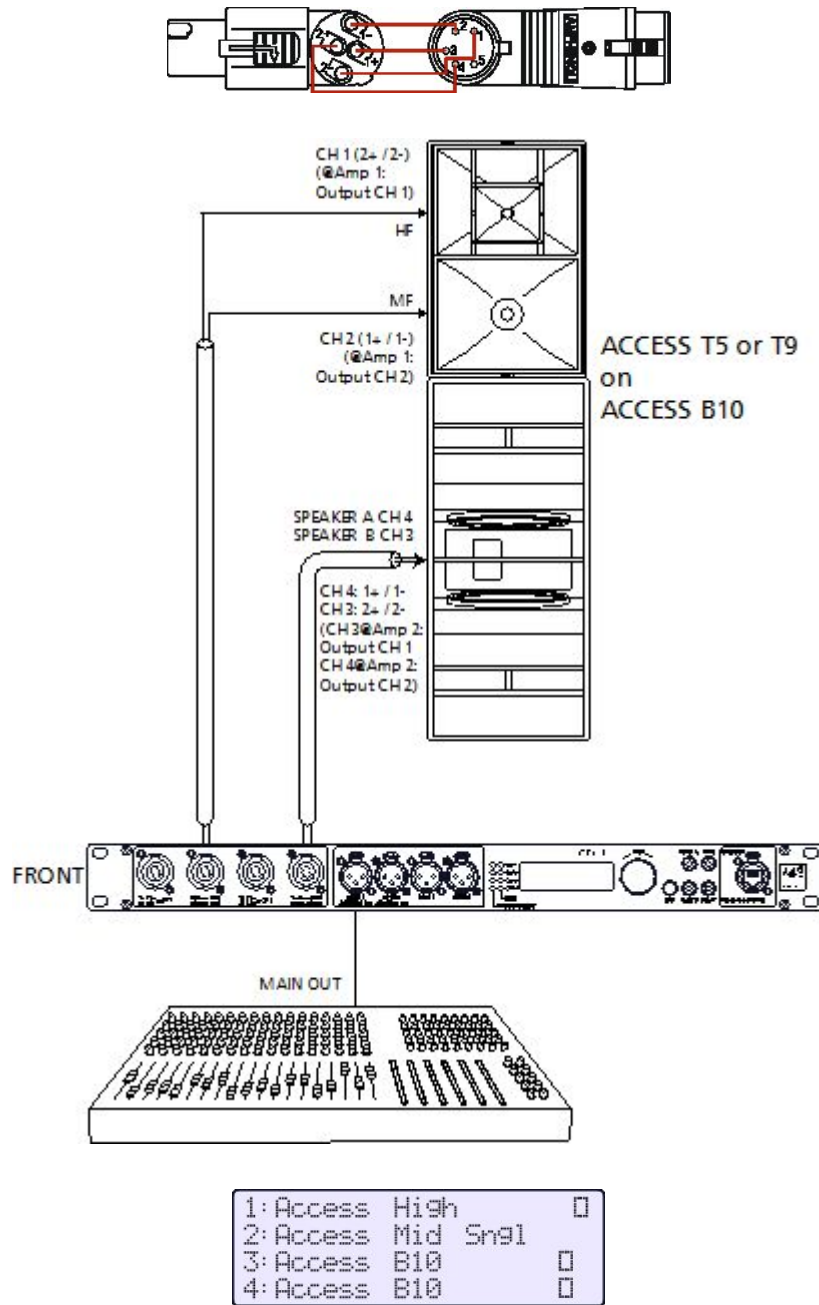

When using with ACCESS speakers, we generally recommend using a connector panel from the K&F CP Series. If you do not have this connector panel, you can also connect the ACCESS speaker directly to the controller with the help of this example.

8.4 Routing '1 in 4 out (Linked)' / Setup 'Example 2'

8.4.1 Block Diagram 'Example 2'

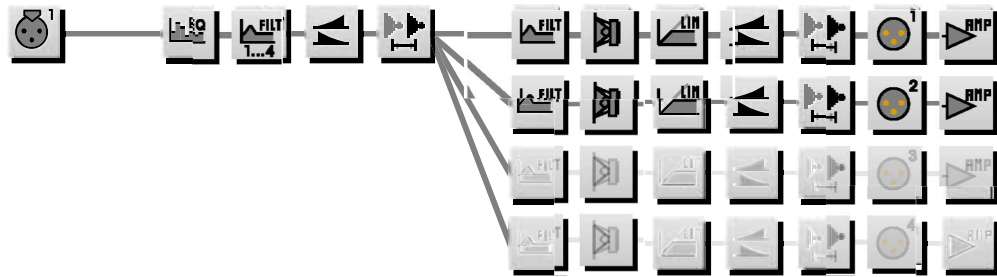

The output section of channel 1 is linked to channel 3

The output section of channel 2 is linked to channel 4.

8.4.2 Setup 'Example 2', 4 x Line 212-6 with 4 x SW 215E

Routing '1 in 4 out (linked)'

The advantage of the routing '1 in 4 out' (linked) as opposed to the routing '1 in 4 out' is that you need to adjust the output section for the Line 212 and SW 215E once only.

If you want to adjust the output sections differently, then you must select the routing '1 in 4 out'!

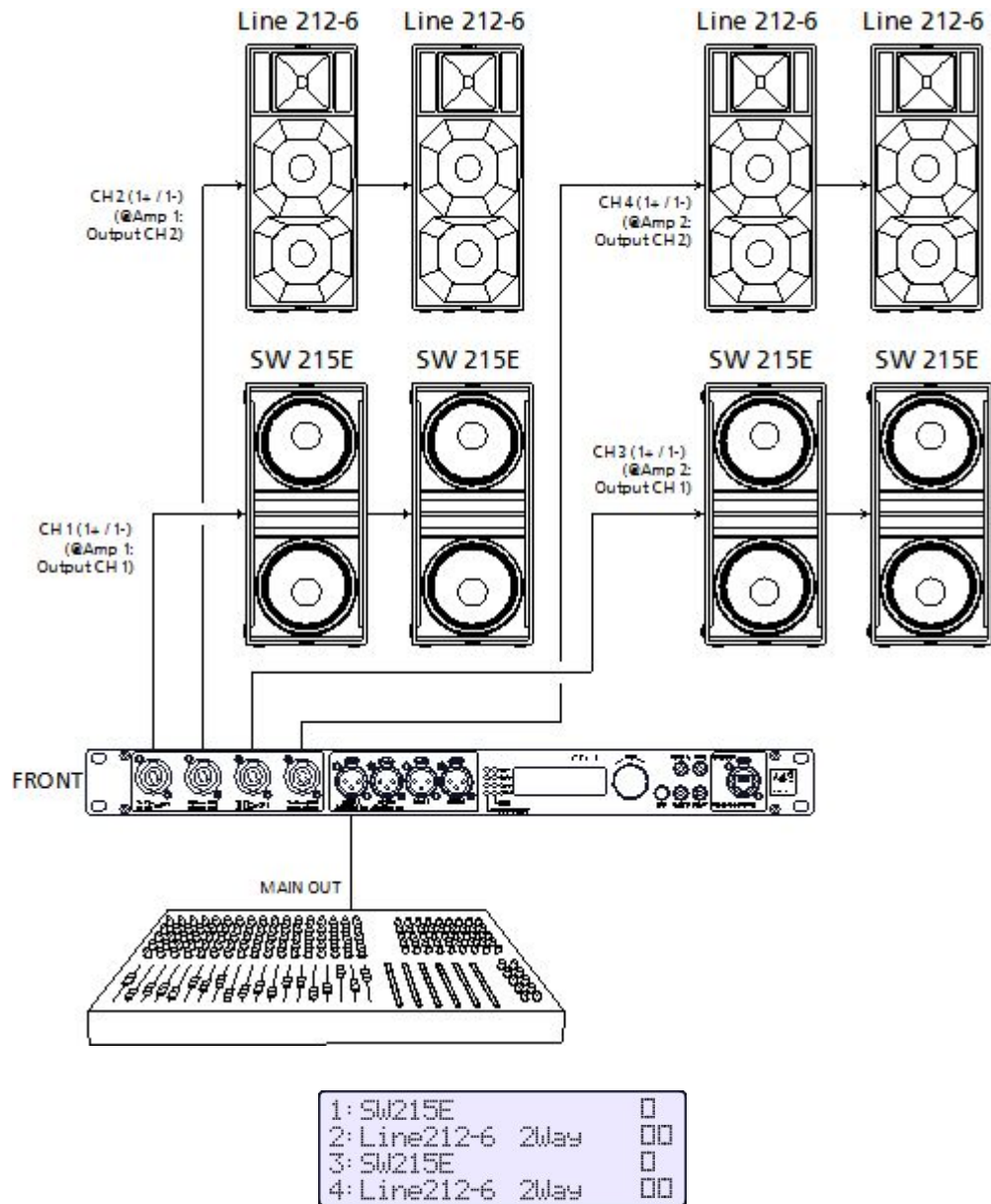

8.5 Routing '2 in 4 out' / Setup 'Example 3'

8.5.1 Block Diagram 'Example 3'

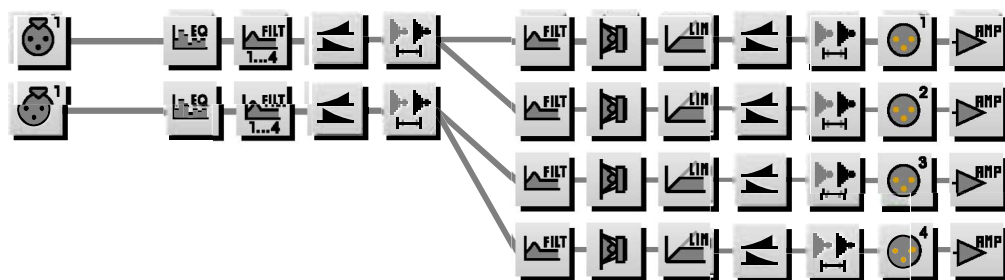

8.5.2 Setup 'Example 3', Line 212/SW 215E & Monitor CA 1215/SW 115E

Routing '2 in 4 out'

This configuration is suitable for the following example: to control one side of a front PA with top and bass speaker, which are supplied from the Main Out of the mixing console and a monitor (side fill) including a top and bass speaker, supplied from the AUX of the mixing console.

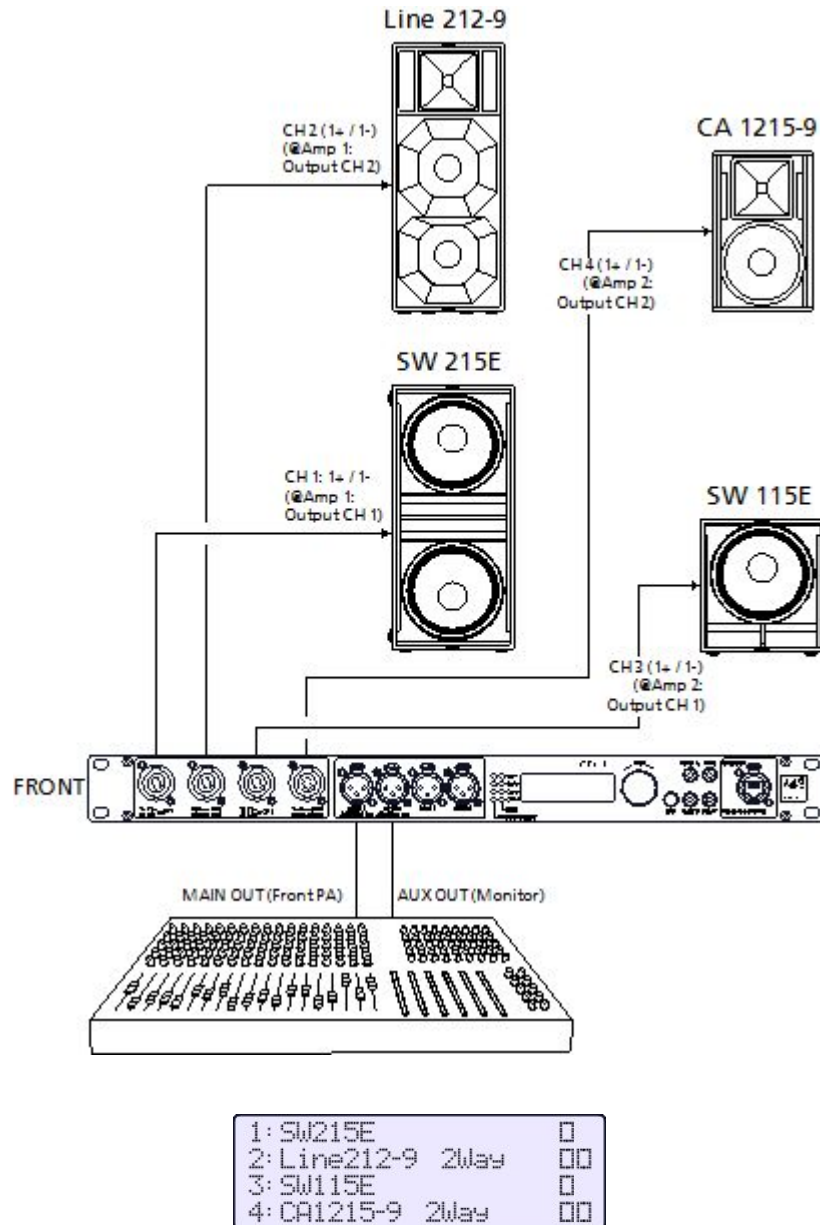

8.6 Routing '2 in 4 out (Linked)' / Setup 'Example 4'

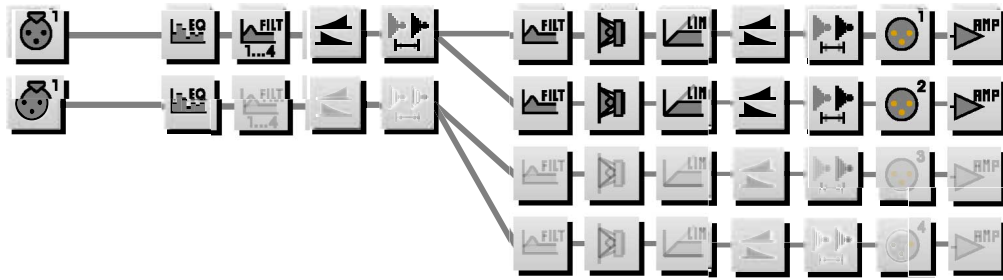

The input section of channel 1 is linked to channel 2 (not EQ 31-Band)

The output section of channel 1 is linked to channel 3

The output section of channel 2 is linked to channel 4.

8.6.1 Setup 'Example 4', Line 212 / SW 215E, stereo

Routing '2 in 4 out (linked)'

If you want to make separate adjustments for the PEQs and/or the 31-band EQ for stereo use, the routing '2 in 4 out' should be used as the standard setting.

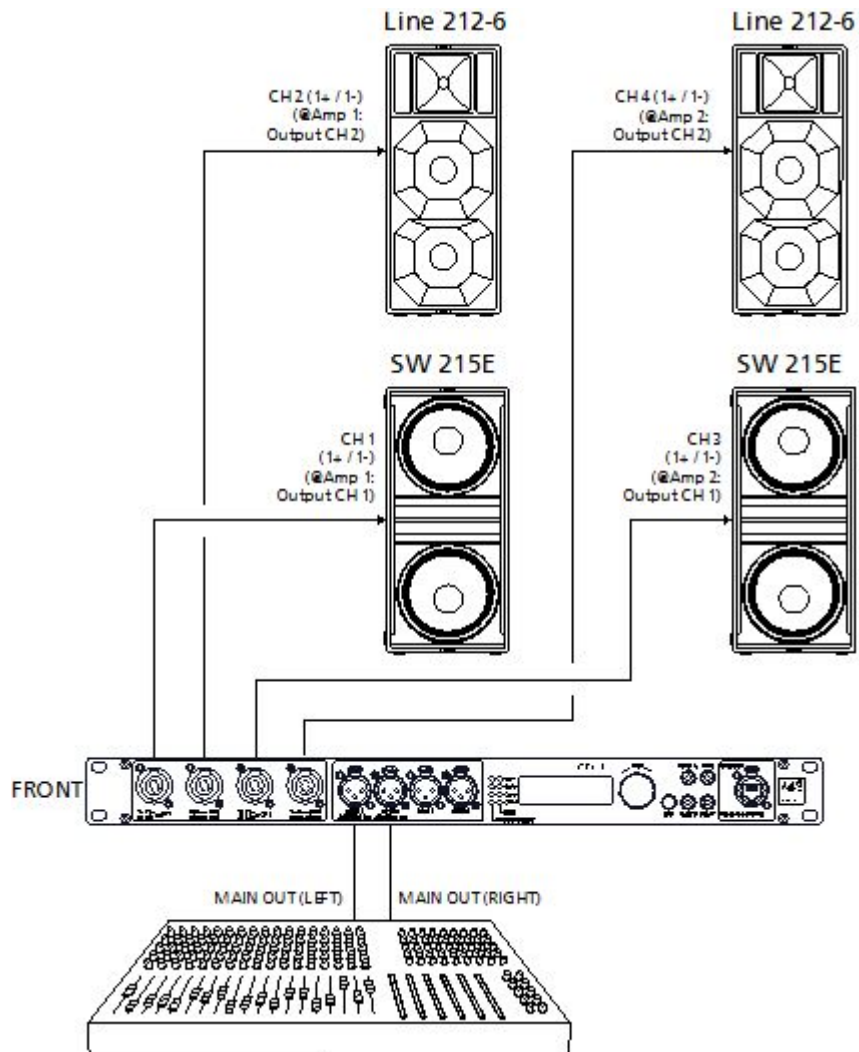

1: SW215E	<input type="checkbox"/>
2: Line212-9 2Way	<input type="checkbox"/>
3: SW115E	<input type="checkbox"/>
4: Line212-6 2Way	<input type="checkbox"/>

8.7 Routing '4 in 4 out' / Setup 'Example 5'

8.7.1 Block Diagram 'Example 5'

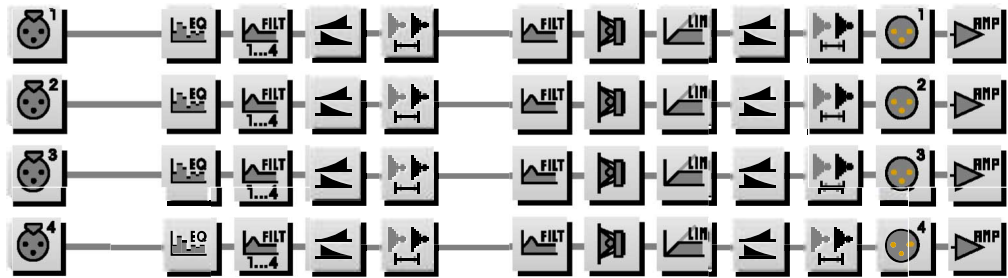

8.7.2 Setup 'Example 5', 4- Way Monitor Setup

Routing '4 in 4 out'

During monitor uses where the speakers are lying on the floor, the Cluster Filter (via Filter B) should be selected.

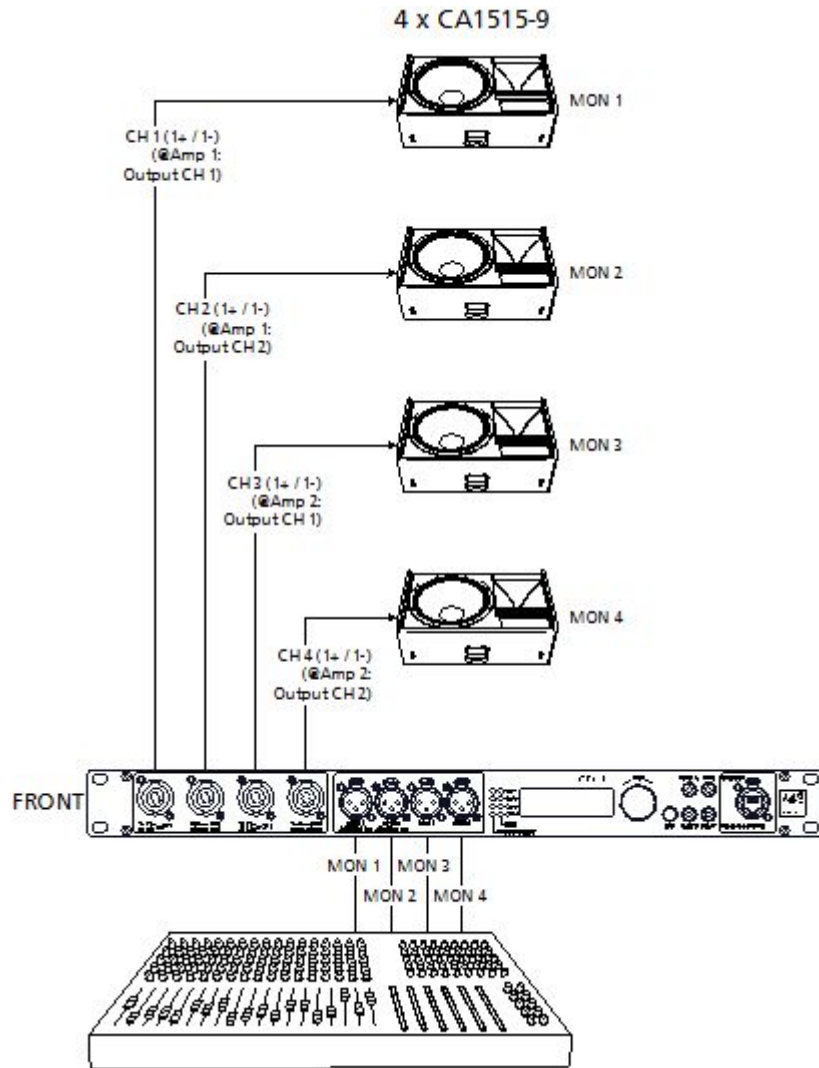

It might make sense to turn the tweeter horns by 90°.

1:	CA1515-9	FR	
2:	CA1515-9	FR	
3:	CA1515-9	FR	
4:	CA1515-9	FR	

8.8 Routing '1 in 2 + 2 in 2' / Setup 'Example 6'

8.8.1 Block Diagram 'Example 6'

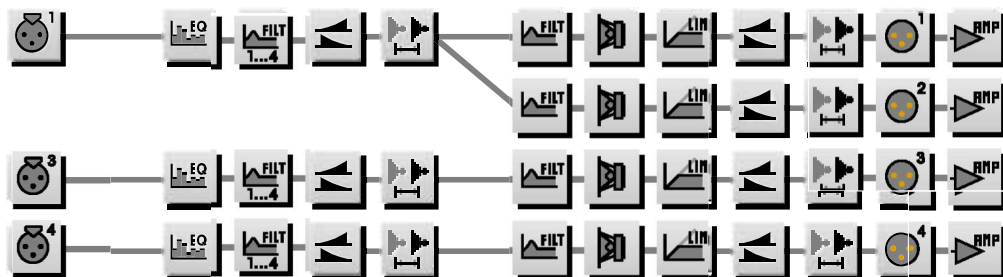

8.8.2 Setup 'Example 6', Front: CA1515 / SW118E + 2 Adjoining Rooms

Routing '1 in 2 + 2 in 2'

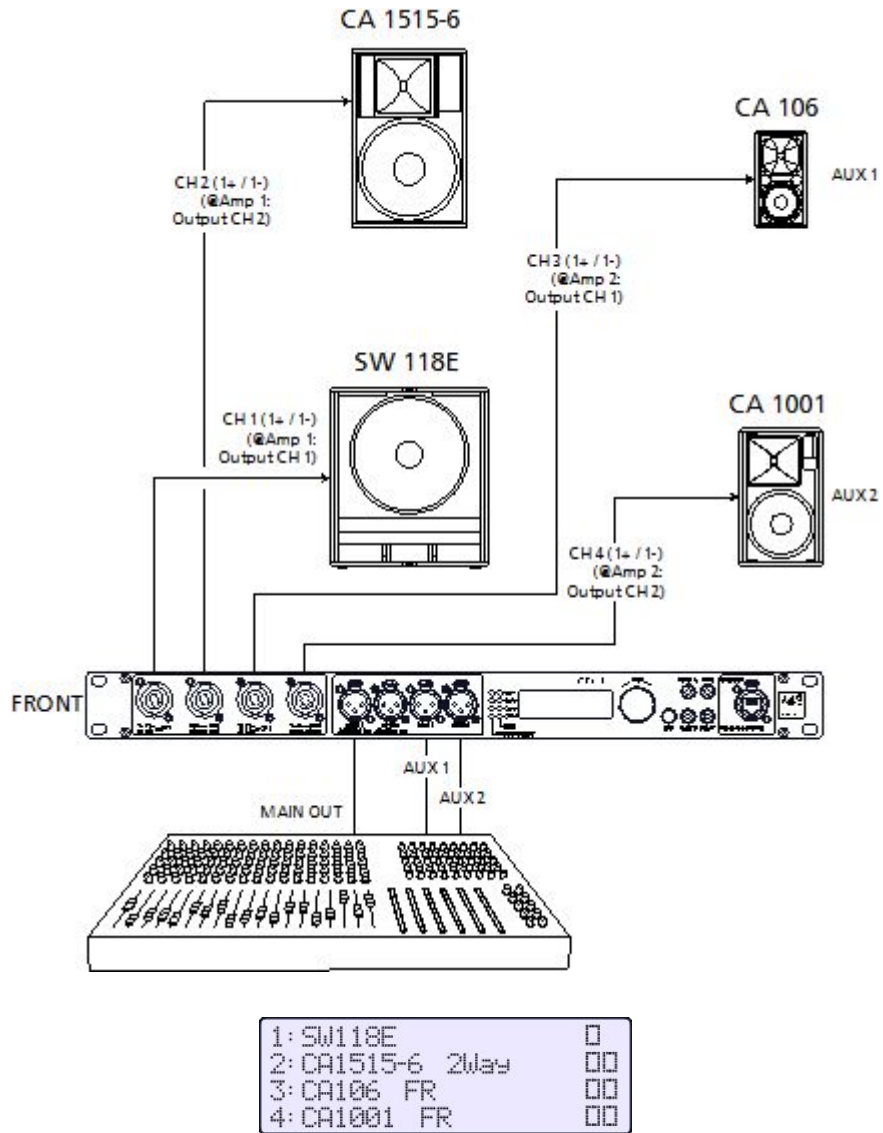

8.9 Routing '1 in 3 + AUX' / Setup 'Example 7'

8.9.1 Block Diagram 'Example 7'

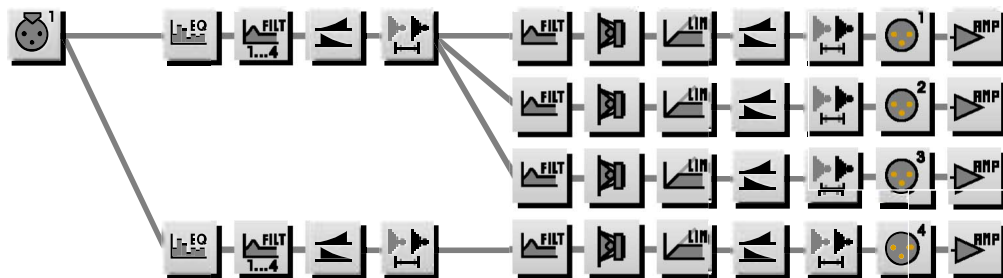

8.9.2 Setup 'Example 7', 3 x SEQUENZA 10 B Cardioid + SW 115 E

The 3 SEQUENZA 10 B's need to be controlled with an identical level and signal. You can achieve this most easily by using the CD 44 routings 1in4out or 1in3out+AUX.

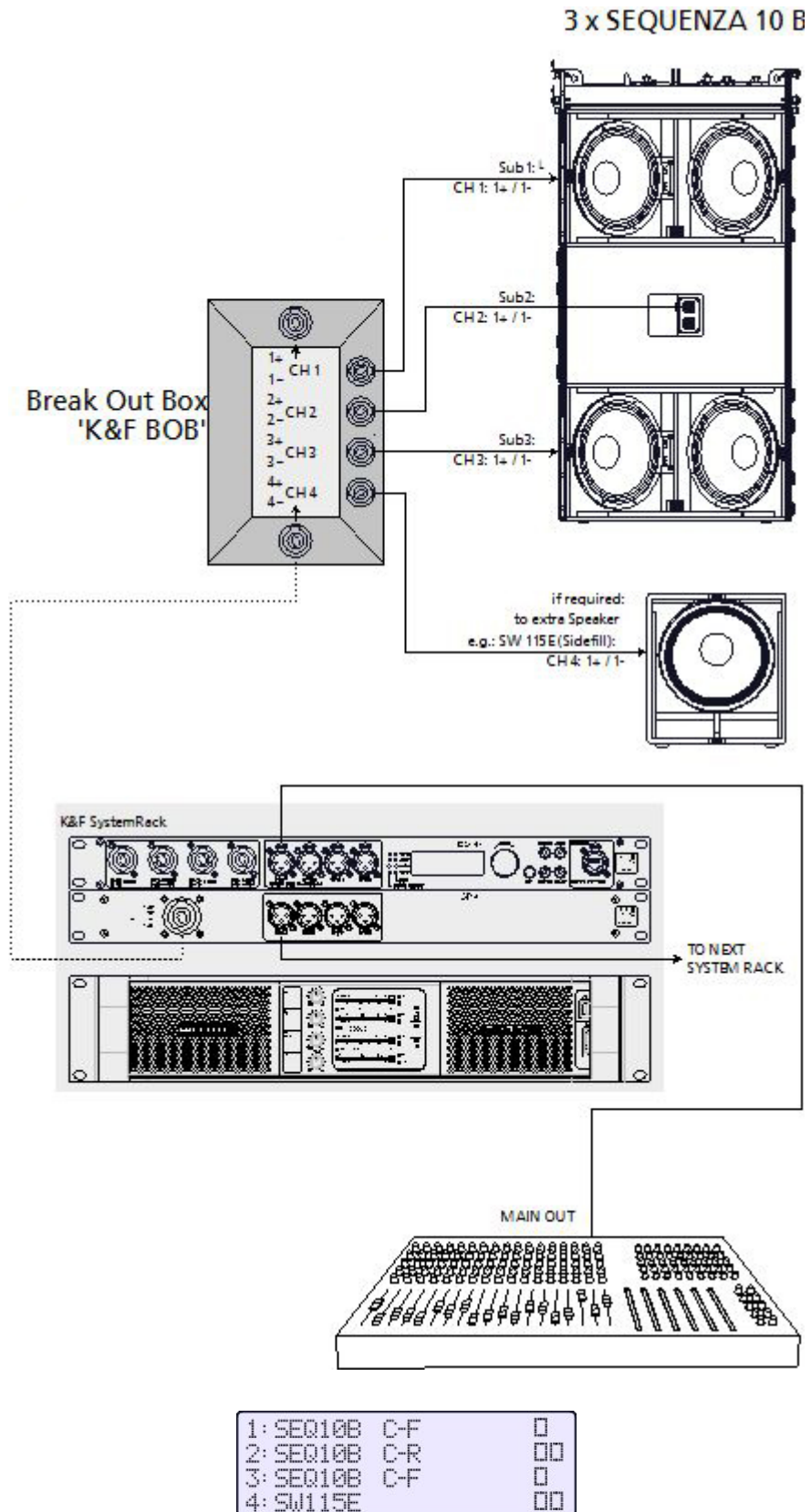

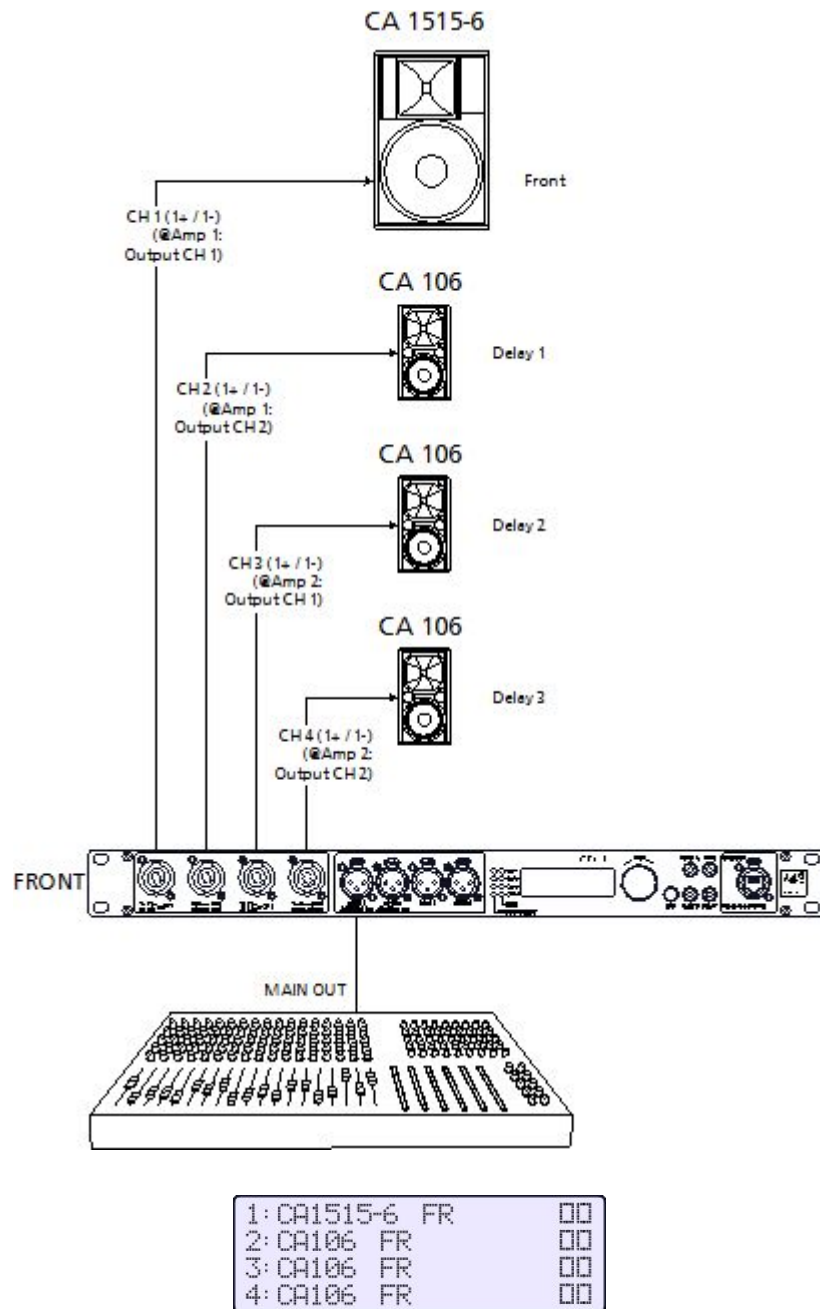

8.11 Routing '1 in 3 + 1 in 1' / Setup 'Example 9'

8.11.1 Block Diagram 'Example 9'

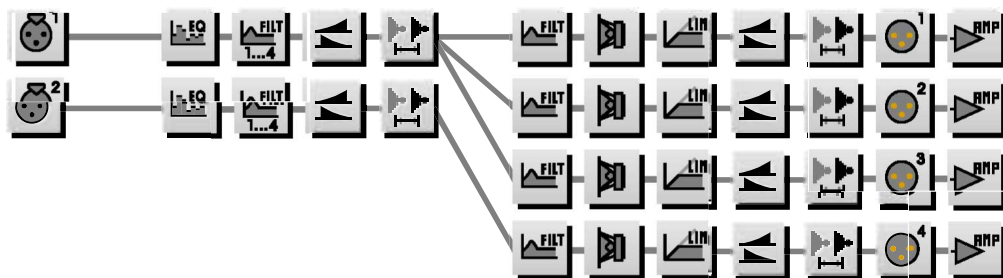

8.11.2 Setup 'Example 9', T5 / T9 with B5 and additional Bass B10

ACCESS setups with additional B10 for a separate deep bass playback of selected signals.

The main out of the mixing console delivers the sum of the signals for the top speakers T5 / T9 as well as for the B5. Selected signals with a high share of deep bass, like bass drum, keyboard, etc. are picked up at the mixing console's AUX path and transmitted to the B10 using a separate controller path.

If the ACCESS T5 or T9 is used with EP-5 connectors, we recommend making and using an adapter cable from Speakon to EP-5.



The current versions of the subwoofer ACCESS B5 and ACCESS B10 have a Speakon connector that is assigned to 1+/1- for both chassis. For these versions, you do not need the following adapter! If you want to connect a 1+/1- assigned ACCESS bass, then connect the ACCESS subwoofer like other 1+/1- assigned K&F subwoofers.

ACCESS B10 with EP -5 connector:

In this example, the B10 is only connected to one channel of the CD 44! A connector is used, though, that supplies 2 channels. When connecting the B10, use a two-core cable with the assignment 1+ and 1-. You should use one of the following adapters at the speaker input of the B10 in order to transmit the signal to both chassis.

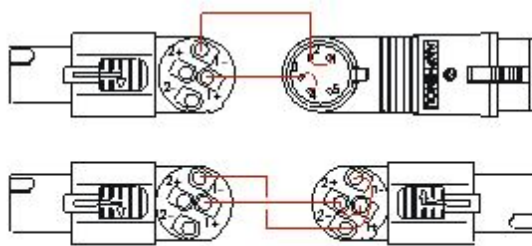

Adapter für Eingangsbuchse
ACCESS B10 mit EP -5
Anschluss

Adapter für Eingangsbuchse
ACCESS B10 mit Speakon
Anschluss

Darstellung des Adapters im Anschlussdiagramm:

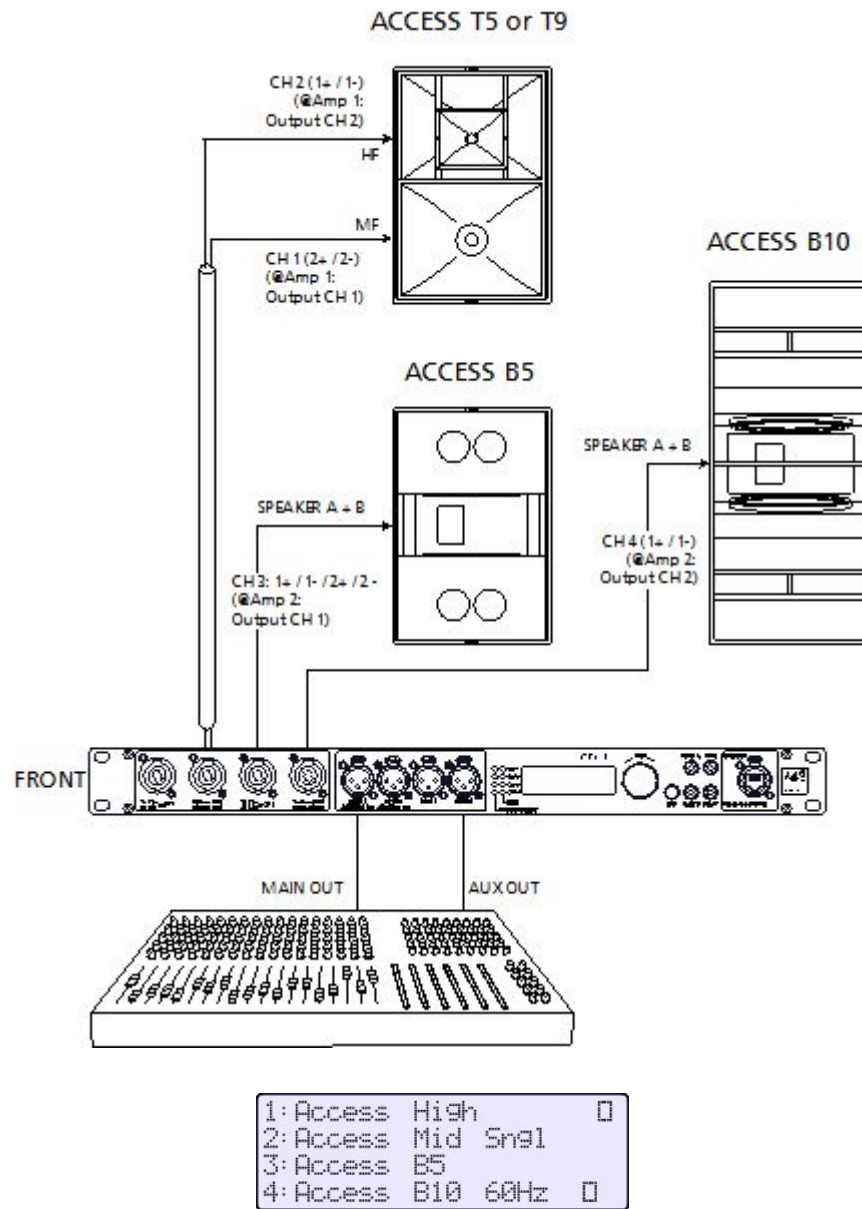

8.12 Routing '2 in 4 in 4' / Setup 'Example 10'

8.12.1 Block Diagram 'Example 10'

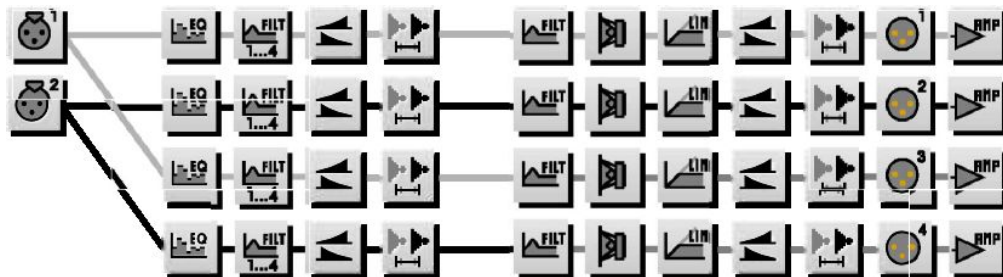

8.12.2 Setup 'Example 10'

Ch1+2 = Main sound system, stereo

Ch3+4 = Sound system in adjoining room, stereo

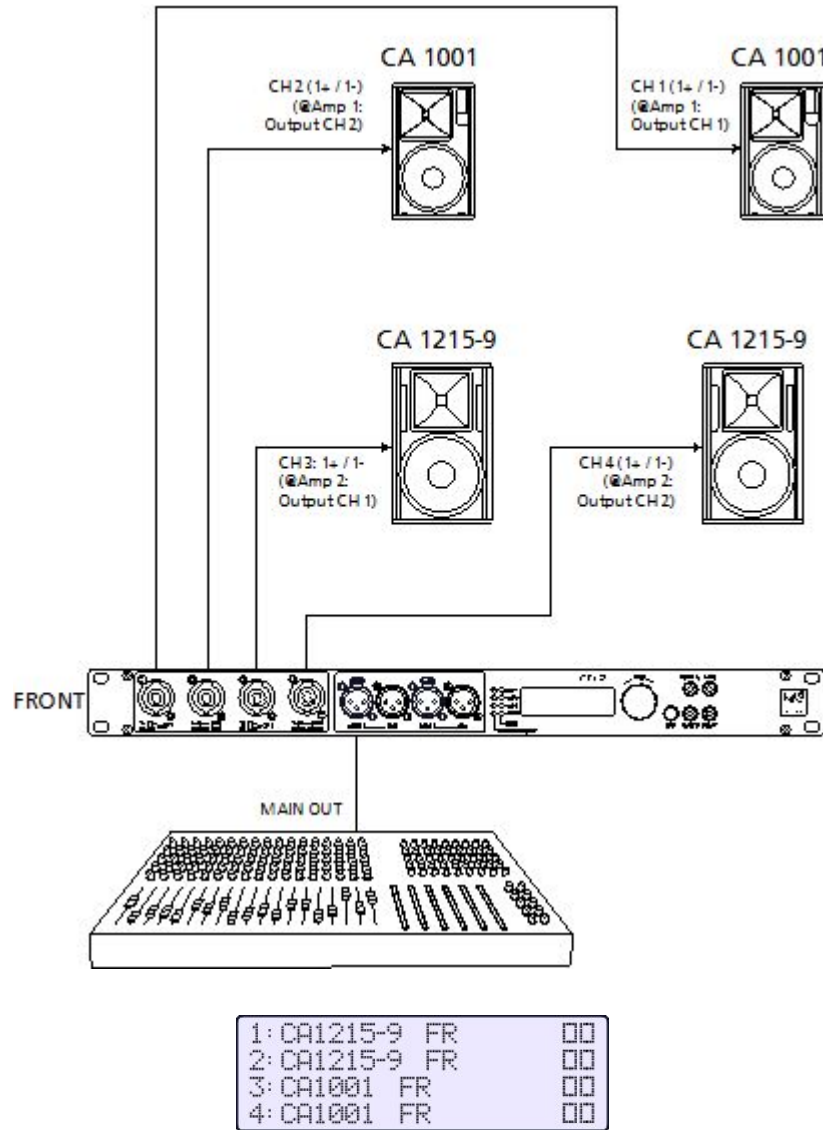

8.13 Routing '1 in 2 + Aux + 1 in 1' / Setup 'Example 11'

8.13.1 Block Diagram 'Example 11'

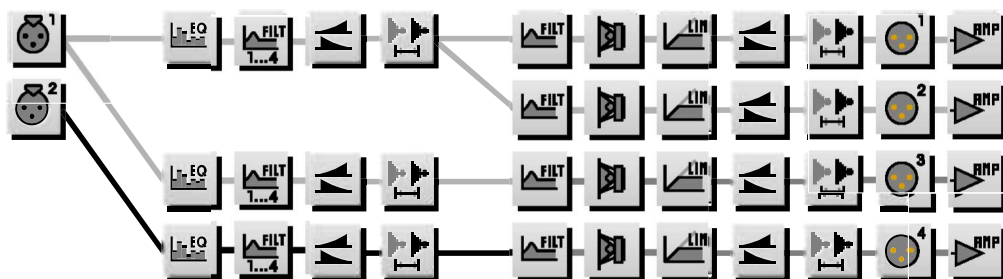

8.13.2 Setup 'Example 11

Ch1+2 = Access top speaker

Ch3 = B5 with separate filter settings

Ch4 = B10 from separate mixing console output

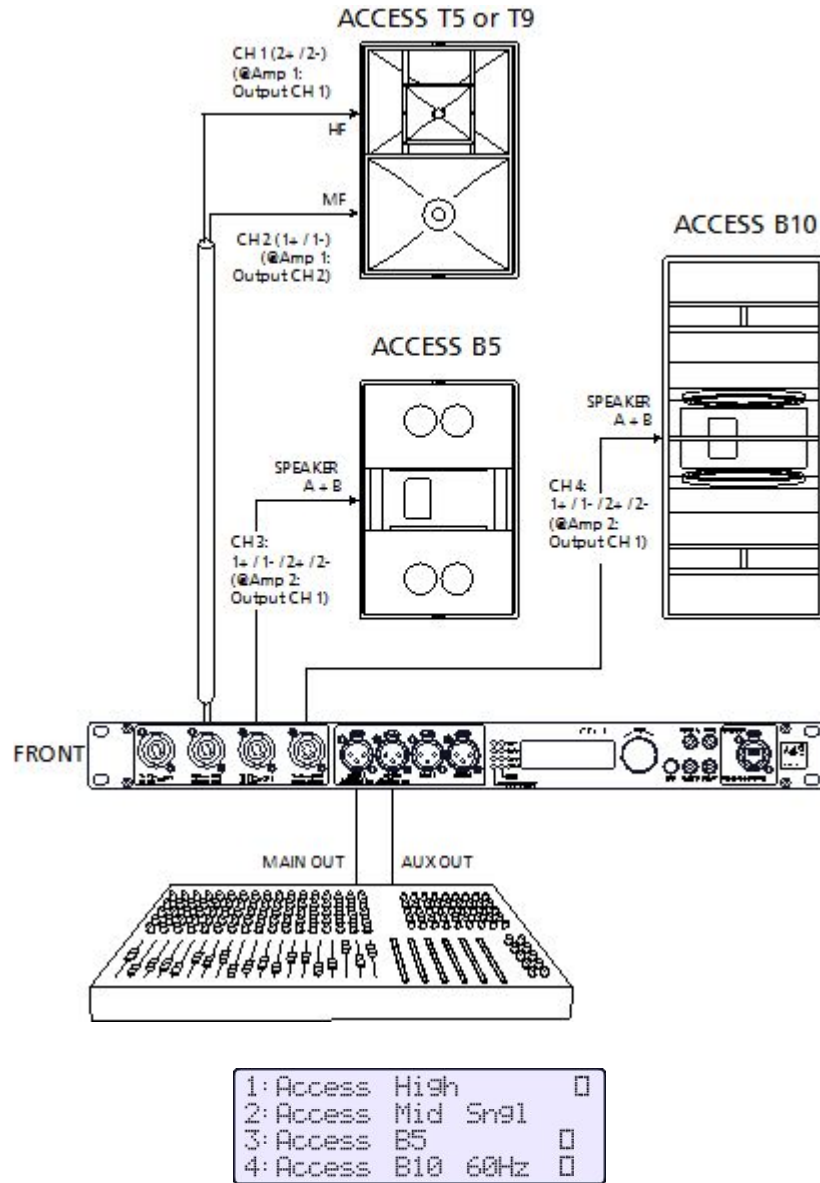

8.14 Patching: Analog 1&2 Mix / Routing '2 in 4 in 4' / Setup 'Example 12

8.14.1 Block Diagram 'Example 12'

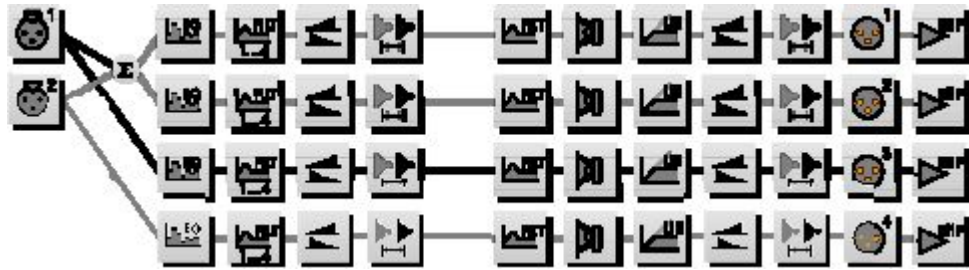

8.14.2 Setup 'Example 12'

Ch1 = Sound system in adjoining room 1, mono (i.e. foyer)

Ch2 = Sound system in adjoining room 2, mono (i.e. cafeteria)

Ch3+4 = Main sound system, stereo

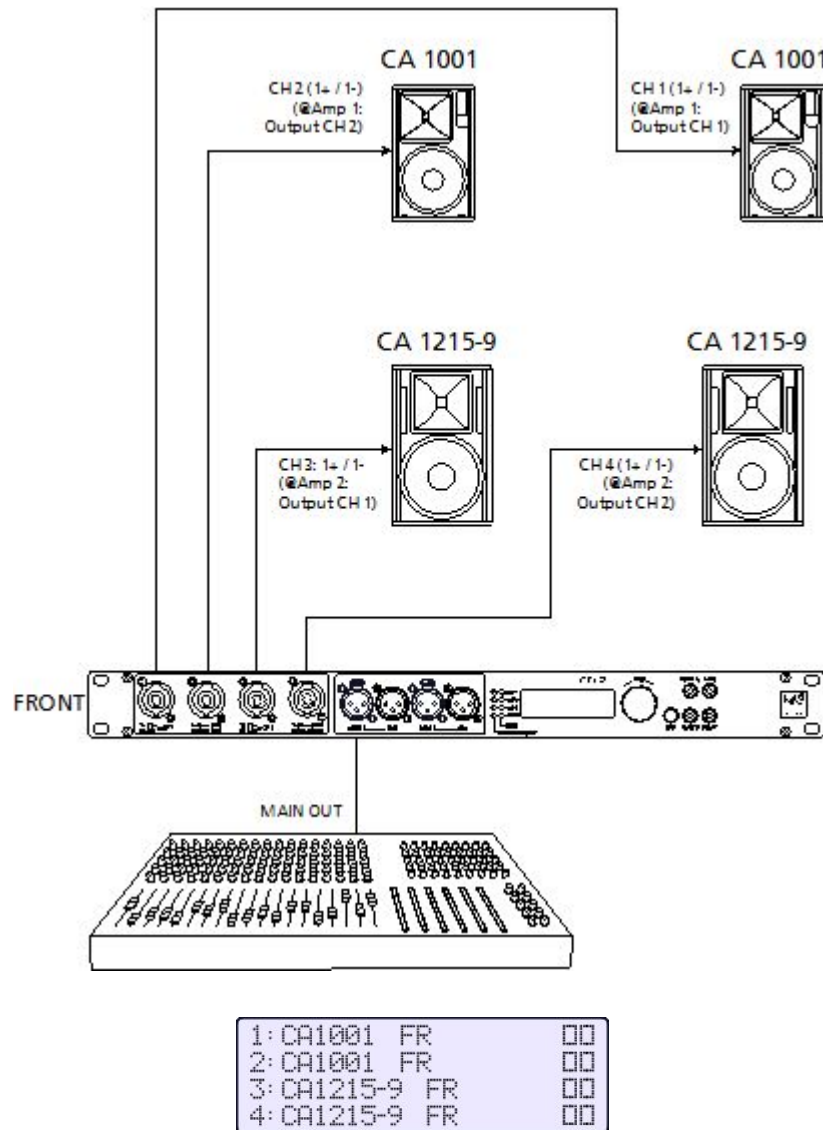

8.15 Sequenza 10 N / W Routing '1 in 4 out' / Setup 'Example 13'

8.15.1 Block Diagram 'Example 13'

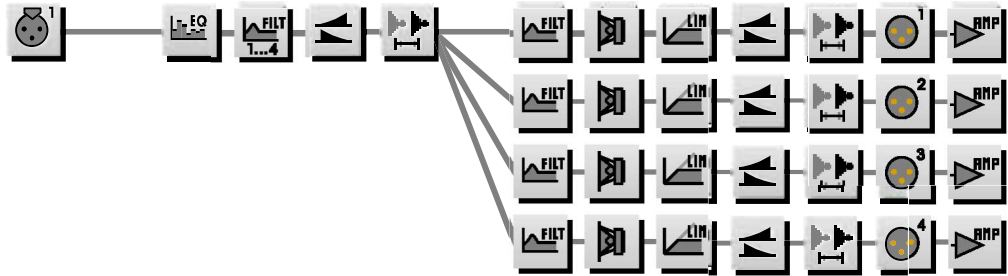

8.15.2 Setup 'Example 13'

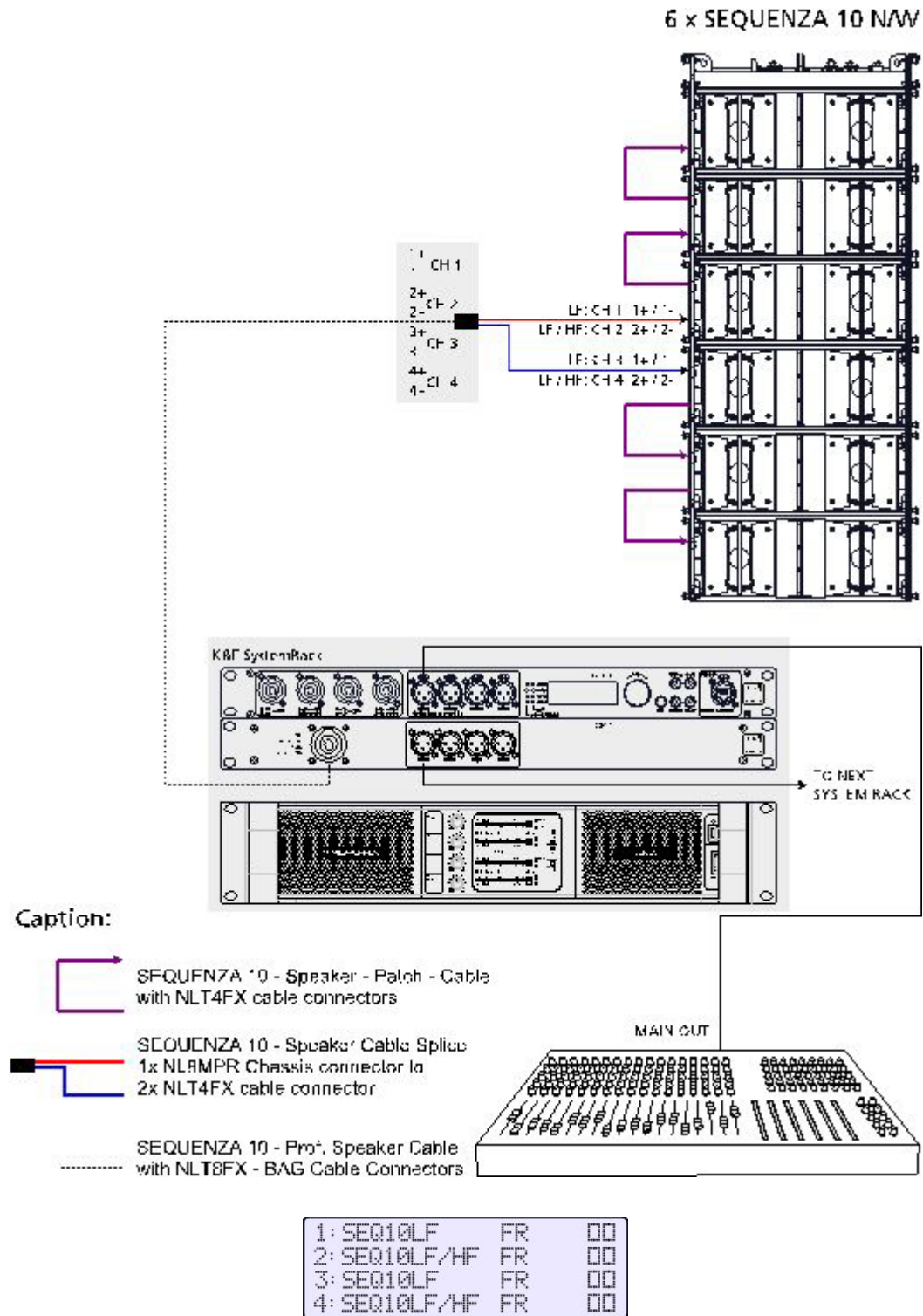

8.16 Sequenza 10 N / W: Routing '1 in 2 + Aux + 1 in 1' / Setup 'Example 14'

8.16.1 Block Diagram 'Example 14'

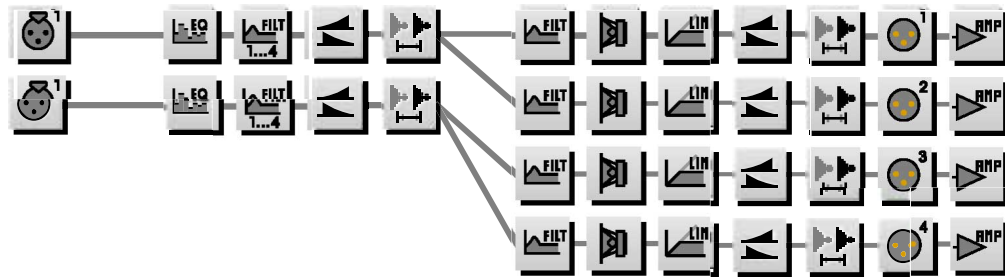

8.16.2 Setup 'Example 14'

Notice

When connecting the Sequenza 10 N / W Systems directly to connector 2 (and / or 4) of the CD 44 without Connector Panel CP 4, then LS-Blocks on channels 1 and 2 (and/or 3 and 4) have to be swapped. Apparent when you compare setup Example 13 with setup Example 14.

The same applies to Nomos XLC. When connecting the Nomos XLC Systems directly to connector 2 (and/or 4) of the CD 44 without Connector Panel CP 4, then LS-Blocks on channels 1 and 2 (and/or 3 and 4) have to be swapped.

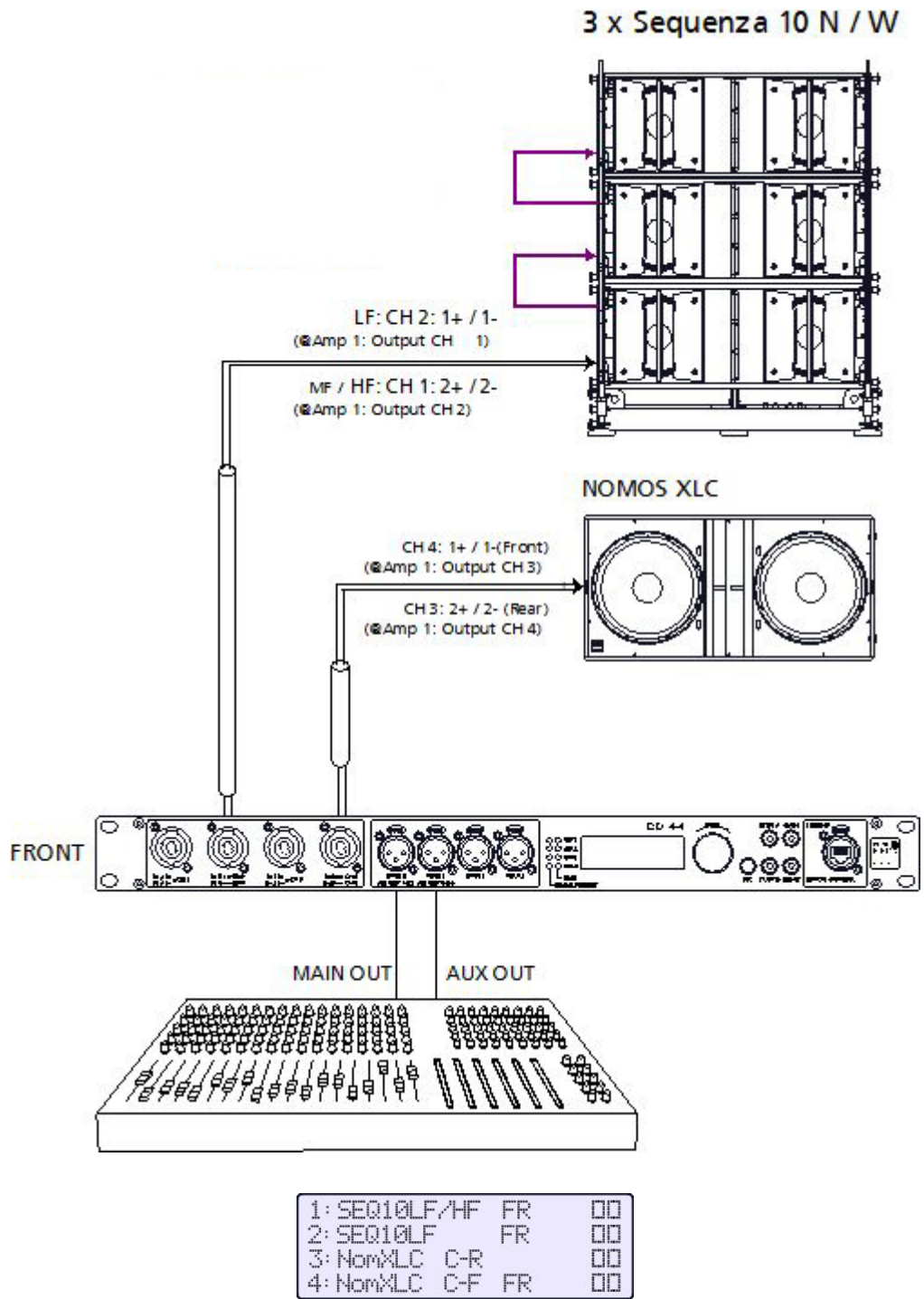

8.17 Patching: Analogue 1&2 Mix / Routing '1 in 2 in 2 + 2 in 2' / Setup 'Example 15'

This setup from top speakers in stereo mode and a subwoofer in 'mono mixed' is suitable as a small front PA. The additional aux can be used as a monitor, delay or adjoining room sound, for example.

CH 1: Subwoofer mono
CH 2 & 3: Main sound stereo
CH 4: Aux, e.g. Monitor

8.17.1 Block diagram, 'Example 15'

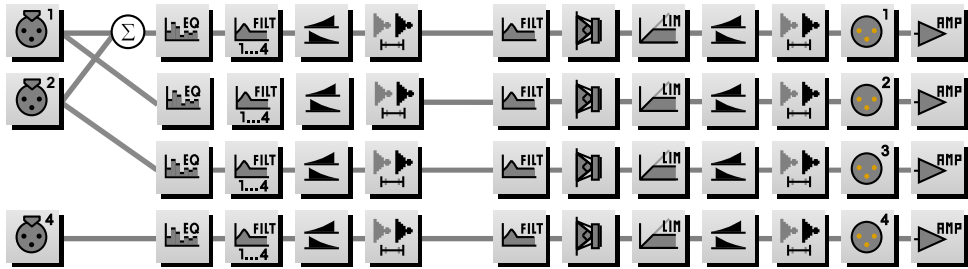

8.17.2 Setup 'Example 15'

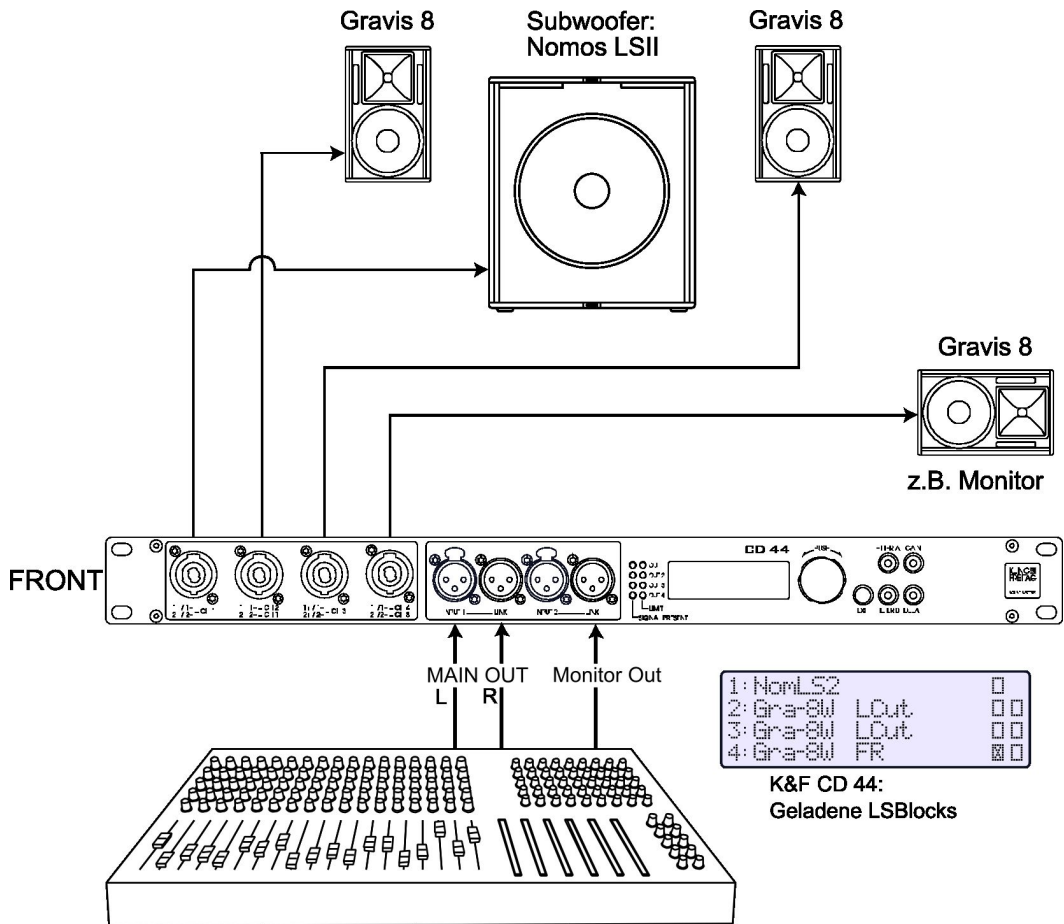

9. Subwoofer with integrated Crossover

When using subwoofers with integrated crossover on the CD 44, set the XO switch on the connecting terminal of the subwoofer to XO 'OFF'.



We do not recommend the passive use of a subwoofer at a top speaker (XO 'ON') on the CD 44.

10. SP Speakers

Notice

The line inputs of the SP speakers are only connected with the desired outputs of the controller (Out 1 through Out 4). Connecting the amplified signal to the connector AMP RETURN / SENSE of the CD 44 is not possible with an SP speaker. This is not necessary, though, because the SP speaker is equipped with its own limiters guaranteeing the operating safety.

If you do not wish to use the limiter in the CD 44, set the AmpGain as followed: <Out » Output 1> through <Output 4 » AmpGain » Gain/dB>: +20.0 (lowest possible value).

If you also wish to use the limiter in the CD 44, i.e. for level limiting, then you must set the AmpGain to +30.0. With this setting, you can select the desired level limit at <Out » Output 1> through <Output 4 » LimitReduction>.

You can use the SP speakers in two different ways on the CD 44:

1. With the LS-Block 'Flat':

With this, the overlap filter characteristic of the SP speaker is maintained. In this case, move the switch 'FILTERS' in the connecting panel of the SP speaker to 'ON' and the Gain potentiometer to 0 dB.

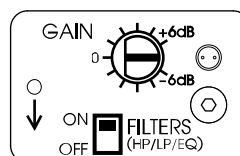

2. With the LS-Block of the respective K&F speaker system:

With this, you can use the filter characteristic for the passive speaker. In this case, select the LS-Block which goes with your SP speaker. For example, select the LS-Block CA 1201 LCut for 2-way operations of the speaker CA 1201-SP, or the CA 1201 FR for full-range use. Move the switch 'FILTERS' in the connecting panel of the SP speaker to 'OFF' and turn the Gain potentiometer on the connecting panel of the SP speaker to 0 dB.

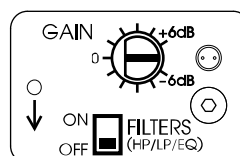

11. Recommendations for Configuration

11.1 Operating several Speakers per CD 44 Channel

The maximum number of speakers which can be operated at one time using the CD 44 Controller is limited by the minimum output impedance of the power amplifiers.

Make sure the power amplifier has sufficient headroom.

No further adjustments need to be made to the CD 44 Controller when operating with several speakers connected to a single controller. There is no need to adjust the limiters. They receive the necessary information via the voltage applied (not via the current).

SP speakers: Up to 50 SP speakers can be connected to one channel.

11.2 The correct Level Balance between Subwoofer and Top Speakers

When setting up the system it is very important to ensure that the volume levels of the tops and subwoofer are correctly balanced.

The sound level of arrayed bass speakers increases by max. +6dB when doubling the number of speakers (+3dB efficiency plus 3dB by doubling the power amplifier level). The loudness of the tops increases in a different manner because of the directivity.

Furthermore, because of missing floor reflections, a flown subwoofer can be several decibels quieter than a subwoofer which is standing on the floor.

With the CD 44, you can adjust this level balance to meet the requirements of different configurations and applications.

In order to intuitively set the output gain, it is important to remember that the output gain must always be set at 0 dB for the following speaker combinations (applies to systems placed on the floor):

- 1 small top and a subwoofer with one chassis
- 1 large top and a subwoofer with two chassis
- ACCESS top T5 or T9 with 2 x ACCESS B5 or 2 x ACCESS B10

CA 106 and CA 1001 are regarded as small tops. All other tops with available LS-Block, except the ACCESS, are considered to be large top.

The following tables show how this relationship is to be set for the particular configurations. In doing so, it also considers if the systems are flown or placed on the floor.

The data given apply to subwoofer placed on the floor and are valid on the condition that all systems are driven by identical power amplifiers with the signals set at the same level. We recommend maximum level).

When using power amplifiers with different gain characteristics it can become necessary to adjust the balance between top and subwoofer using the output gain control of the CD 44.







Depending upon room acoustics and geometry the correct settings may well differ in practice from that given here. For this reason the sound engineer should always carry out a fine adjustment.

11.2.1 SW 112 / SW 115D / SW 115E / SW 118E

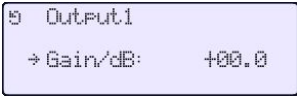

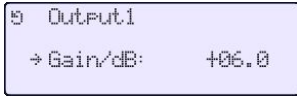

Prerequisite:

- identical power amplifiers for tops and subwoofers with identical volume settings.
- subwoofers placed on the floor.

1 Subwoofer with 1 Top

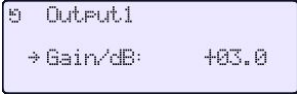

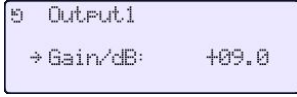
Topteil & Subwoofer	1 x CA 106	1 x CA 1201
		1 x CA 1215
	1 x CA 1001	1 x CA 1515
		1 x Line 212
1 x SW 112	Output gain for subwoofer*  Accessible with: 	Output gain for subwoofer*  Accessible with: 
1 x SW 115D / SW 115E		
1 x SW 118E		
Switch off 'Cluster' (via Filter B) for tops and subwoofers* 		Accessible with:  FILTER B

*Output1 / Out 1 as an example. Select the output which is connected to the speaker!

1 Subwoofer with 2 tops		
Topteil & Subwoofer	2 x CA 106	2 x CA 1201
		2 x CA 1215
	2 x CA 1001	2 x CA 1515
		2 x Line 212
1 x SW 112	Output gain for subwoofer*  Accessible with: 	Output gain for subwoofer*  Accessible with: 
1 x SW 115D / SW 115E		
1 x SW 118E		
Switch on 'Cluster' (via Filter B) for tops and subwoofer, when the tops are placed on the subwoofer*		Accessible with:



<div style="border: 1px solid black; padding: 5px; width: fit-content; margin: 0 auto;"> <pre> Cluster ->Out1 ? Status: off </pre> </div>	 FILTER B
---	--

*Output1 / Out 1 as an example. Select the output which is connected to the speaker!

2 Subwoofer with 1 Top		
Topteil & 2 Subwoofer	1 x CA 106	1 x CA 1201
		1 x CA 1215
	1 x CA 1001	1 x CA 1515
		1 x Line 212
2 x SW 112	Output gain for subwoofer* <div style="border: 1px solid black; padding: 2px; width: fit-content; margin: 0 auto;"> <pre> Output1 Gain/dB: -06.0 </pre> </div> Accessible with:  GAIN	Output gain for subwoofer* <div style="border: 1px solid black; padding: 2px; width: fit-content; margin: 0 auto;"> <pre> Output1 Gain/dB: +00.0 </pre> </div> Accessible with:  GAIN
2 x SW 115D / SW 115E		
2 x SW 118E		
Switch off 'Cluster' (via Filter B) for tops and subwoofers*		Accessible with:
<div style="border: 1px solid black; padding: 5px; width: fit-content; margin: 0 auto;"> <pre> Cluster ->Out1 ? Status: off </pre> </div>		 FILTER B

*Output1 / Out 1 as an example. Select the output which is connected to the speaker!



2 Subwoofer with 2 tops		
2 Subwoofer with 2 tops	2 x CA 106	2 x CA 1201
		2 x CA 1215
	2 x CA 1001	2 x CA 1515
		2 x Line 212
2 x SW 112	Output gain for subwoofer* <div style="border: 1px solid black; padding: 2px; width: fit-content; margin: 0 auto;"> <pre> Output1 Gain/dB: -3.0 </pre> </div> Accessible with:	Output gain for subwoofer* <div style="border: 1px solid black; padding: 2px; width: fit-content; margin: 0 auto;"> <pre> Output1 Gain/dB: +03.0 </pre> </div> Accessible with:
2 x SW 115D / SW 115E		
2 x SW 118E		

	<p>GAIN</p> 	<p>GAIN</p> 
<p>Switch on 'Cluster' (via Filter B) for tops and subwoofer, when the tops are placed on the subwoofer*</p>		<p>Accessible with:</p>  <p>FILTER B</p>
<div style="border: 1px solid black; padding: 5px; width: fit-content; margin: auto;"> <pre> Cluster ->Out1 ? ->Status: on </pre> </div>		

*Output1 / Out 1 as an example. Select the output which is connected to the speaker!







11.2.2 SW 215E / ACCESS B5 & B10 / SEQUENZA 10 B / NOMOS XLC

- identical power amplifiers for tops and subwoofers with identical volume settings.
- Subwoofers placed on the floor



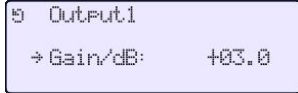

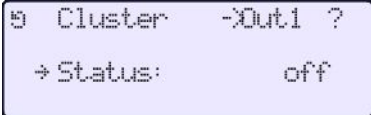

1 Subwoofer with 1 Top		
<p>Topteil & Subwoofer</p>	<p>1 x CA 106</p>	<p>1 x CA 1201</p>
		<p>1 x CA 1215</p>
	<p>1 x CA 1001</p>	<p>1 x CA 1515</p>
		<p>1 x Line 212</p>
<p>1 x SW 215E</p>	<p>Output gain for subwoofer*</p>	<p>Output gain for subwoofer*</p>
<p>1 x ACCESS B5</p>	<div style="border: 1px solid black; padding: 5px; width: fit-content; margin: auto;"> <pre> Output1 ->Gain/dB: -06.0 </pre> </div>	<div style="border: 1px solid black; padding: 5px; width: fit-content; margin: auto;"> <pre> Output1 ->Gain/dB: +00.0 </pre> </div>
<p>1 x ACCESS B10</p>		
<p>1 x NOMOS XLC</p>	<p>Accessible with:</p>	<p>Accessible with:</p>
<p>1 x SEQUENZA 10 B</p>	<p>GAIN</p> 	<p>GAIN</p> 
<p>Switch off 'Cluster' (via Filter B) for tops and subwoofers*</p>		<p>Accessible with:</p>  <p>FILTER B</p>
<div style="border: 1px solid black; padding: 5px; width: fit-content; margin: auto;"> <pre> Cluster ->Out1 ? ->Status: off </pre> </div>		

*Output1 / Out 1 as an example. Select the output which is connected to the speaker!

1 Subwoofer with 2 tops		
<p>2 tops &</p>	<p>2 x CA 106</p>	<p>2 x CA 1201</p>

1 subwoofer		2 x CA 1215
	2 x CA 1001	2 x CA 1515
		2 x Line 212
1 x SW 215E	Output gain for subwoofer*  Accessible with: 	Output gain for subwoofer*  Accessible with: 
1 x ACCESS B5		
1 x ACCESS B10		
1 x NOMOS XLC		
1 x SEQUENZA 10 B		
Switch off 'Cluster' (via Filter B) for tops and subwoofers*		Accessible with:  

*Output1 / Out 1 as an example. Select the output which is connected to the speaker!

2 Subwoofer with 1 Top		
Topteil & 2 Subwoofer	1 x CA 106	1 x CA 1201
	1 x CA 1001	1 x CA 1215
		1 x CA 1515
		1 x Line 212
2 x SW 215E	Output gain for subwoofer*  Accessible with: 	Output gain for subwoofer*  Accessible with: 
2 x ACCESS B5		
2 x ACCESS B10		
2 x NOMOS XLC		
2 x SEQUENZA 10 B		
Switch off 'Cluster' (via Filter B) for tops and subwoofers*		Accessible with:  

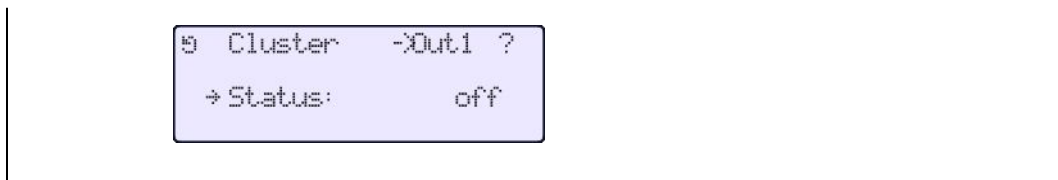

*Output1 / Out 1 as an example. Select the output which is connected to the speaker!

Prerequisite:

2 Subwoofer mit 2 tops		
2 tops & 2 Subwoofer	2 x CA 106	2 x CA 1201
		2 x CA 1215
	2 x CA 1001	2 x CA 1515
		2 x Line 212
2 x SW 215E	Output gain for subwoofer* Accessible with: 	Output gain for subwoofer* Accessible with:
2 x ACCESS B5		
2 x ACCESS B10		
2 x NOMOS XLC		
2 x SEQUENZA 10 B		
Switch off 'Cluster' (via Filter B) for tops and subwoofers* 		Accessible with:

*Output1 / Out 1 as an example. Select the output which is connected to the speaker!

12. Instructions for AES / EBU Data Transmission

12.1 General Instructions

The interface AES / EBU offers the possibility to transmit two digital audio channels via a balanced cable. The sampling rate of the audio signal may be 32 kHz, 44.1 kHz, 48 kHz, 88.2 kHz, 96 kHz or 192 kHz with a resolution of max. 24 bits. The Kling & Freitag CD 44 System Controller supports any type of sampling rates ranging from 44.1 kHz to 192 kHz with a resolution of max. 24 bits.

When using the AES / EBU input, in addition to the system delay of 0.5 ms, a further delay arises from the sample rate converter: With a sample rate of 44.1 kHz = approx. 2.4 ms. With a sample rate 48 kHz = approx. 2.2 ms. With a sample rate 88.2 kHz = approx. 1.5 ms. With a sample rate 96 kHz = approx. 1.4 ms.

As the handling of digital audio signals in practice differs from that of analogue signals, you should observe the following suggestions in order to ensure dependable operations:

- The maximum cable length between two devices is 150 m.
- Use shielded 'Twisted Pair' cables with an impedance of 110 Ohm (80 - 150 Ohm are tolerable). They are available at specialty stores and are called 'AES/EBU Cables'.
- Do not mix any cables with different impedance within one transmission line.
- Do not use any 'classical' XLR audio cables!
- The cable may not be bent too much or pulled over sharp edges. Please observe the permissible minimal bending radius which is provided by your cable's manufacturer.
- Ensure the soundness of the connectors.
- If the AES/EBU signal is to be distributed over several lines of CD 44, then a special line splitter is necessary.

If no special 110 Ohm AES/EBU cable is available, then data cables for lighting technology (DMX data cable with an impedance of 120 Ohm) can be used.

12.2 Transmissions over long Distances

If transmission distances exceeding 150 m need to be covered, it is necessary to use a repeater.

The interface AES / EBU is the European Broadcasting Union's implementation of the Standards AES3 defined by the Audio-Engineering Society.

Further information is available at these organisations:

www.aes.org und www.ebu.ch

13. Wiring

Make sure that all units are switched off and all controls are turned down before connecting your system.

- Only use high-quality speaker cables, (i.e. from KLING & FREITAG).
- Adapters for connections between the Speakon connecting panel of the CD 44 and EP-5 / XLR-connectors, as well as for special uses must be professionally constructed.
- For analogue connections from the mixing console to the CD 44 and from the CD 44 to the power amplifier inputs, please use shielded microphone cable with two conductors. For digital signal transmission you will need shielded twisted pair cables.
- Please pay attention to the respective pin diagrams in this manual!
- Avoid ground loops.
- Make sure that the +/- polarity of the speakers at the amplifier is correct. When simultaneously using power amplifiers from different manufacturers, be sure to use the correct specific pin configuration. It may be necessary to modify the pin configuration on the power amplifiers or on the connectors leading to them.
- Ensure that the connected speaker channels are working in phase (phase checker). A phase error can also be recognized when the connected channels are used simultaneously. During simultaneous use the bass frequencies become notably quieter or the mid-frequencies such as voices cannot be located.
- The cables should have a sufficient wire gauge. A minimum wire gauge can be easily calculated with the following formula:
Wire Gauge [mm²] = Required Cable Length [m] / 2 x Impedance [Ω]
- Please make sure that the total impedance of the loudspeakers is not lower than the minimal load impedance indicated on the power amplifier.

14. Operating the Speakers

- Operating the Controller

-
- Switch off all equipment and turn down all level controls of the mixing console and the power amplifiers.
 - Wire the speaker systems according to the instructions in this manual.
 - Now switch on the mixing console first, followed by the CD 44 Controller and, at last, the power amplifiers. Always use the before mentioned switching order. Otherwise switching noises may damage the system.
 - If there is interference, turn off all appliances in the reverse order and check all cable connections.
 - Successively turn up the individual power amplifier channels and send a signal with low volume to the system. Check to see if the desired signals are applied to the intended speakers and make sure there is no interference. Make sure everything works properly, i.e. if the signals come from the correct speaker paths (high signals from the tweeters, bass signals from the bass speaker). The SIGNAL-LEDs of the CD 44 Controller light up if there is an output signal greater than -45 dB. Your system is ready for use.
 - Turning down the input level controls may not always prevent distortions in the input section of the power amplifier, especially if this section has a relatively low headroom. A clipping signal may not be displayed by the clipping indicator then! To prevent signal interruptions caused by protection circuits or damages to the speakers, turn the level controls of the power amplifier to the maximum position, if possible. Only turn up the signal level at the mixing console or on the controller far enough so that the power amplifiers are not overloaded; or reduce the limiter threshold at the controller (<Out1> through <Out4 » LimReduction>).
 - When turning off the system, the input controls for the power amplifiers should be turned down first followed by the power switches of the amplifiers. After that, the other appliances can be turned off.

15. Technical Specifications CD 44

Input Signal Processing	
Input delay	delay up to 200 ms with 100 μ s resolution
Filters	31-band graphic EQ 4 selectable filters (Bell, LShelv, HShelv, HighP, LowP, AP)
AMPLIFICATION	digital gain control +20 dB to -96 dB
Sense Inputs	
Output delay	40 ms total (2 x 20 ms) with 10 μ s resolution,
Filters	31-band graphic EQ 4 selectable filters (Bell, LShelv, HShelv, HighP, LowP, AP)
Limit	RMS and peak limiter in the speaker specific K&F LS-Blocks
Gain	digital gain control +20 dB to -96 dB
Sense Inputs	
Maximum input level	150 Vrms
Gain determination	20 dB to 45 dB
Analog-to-Digital Inputs	
Input impedance	10 kOhm balanced, 10 kOhm unbalanced, electronically balanced
Nominal input level	+6 dBu
Maximum input level	+18 dBu
Frequency response	+0/-0,2 dB, 2 Hz bis 20 kHz
THD + noise	0.0006 % (-105 dB) typical @ 1 kHz/-1 dBfs
Dynamic range	119 dB typical, 20 Hz to 20 kHz, A-weighted @ +18 dBu
CMRR	75 dB typical @ 1 kHz, 70 dB typical @ 20 kHz 65 dB, 20 Hz to 20 kHz,
AES / EBU Inputs	
Supported resolutions	up to 24 bit

Supported sample rates	44.1 - 192 kHz, internal dejittering via sample rate converter
Digital-to-Analog Outputs	
Output impedance	<40 Ohm, electronically balanced
Nominal output level	+6 dBu
Maximum output level	+18 dBu
Frequency response	+0/-0.2 dB, 2 Hz to 20 kHz
THD + noise	0.0006 % (-105 dB) typical @ 1 kHz/-1 dBfs
Dynamic range	119 dB typical, 20 Hz to 20 kHz, A-weighted @ +18 dBu
Analog-In to Analog-Out	
Frequency response	20 Hz to 20 kHz, ± 0.1 dB
Dynamic range	115 dB typical, 20 Hz to 20 kHz, unweighted
THD + noise	0.0007 % (-103 dB) typical @ 1 kHz / +17 dBu (all gains zero) 0.001 % (-100 dB) typical @ 1 kHz / +6 dBu (all gains zero)
Conversion resolution	24 Bit
Internal sample rate	96 kHz
Internal data path	28 bit integer, arithmetic precision: 76 bit
System propagation delay	0.5 ms (analogue to analogue)
Remote Interface	
	RJ45 EtherCon™ connector for a 10/100Base-TX ethernet (IP) connection
Power supply	
AC	100 - 240 V~ / 50 - 60 Hz
I nom.	150 - 100 mA
Dimensions and Weight	
Dimensions (W x H x D*)	1 RU rack mount: 483 x 44 x 192 mm (19" x 1.75" x 7.6") *installation depth incl. power cord 260 mm (10.236")

Weight

1.8 kg (3.97 lb)

16. Disposal

Please recycle the packaging material of the device.

16.1 Germany

It is not allowed to dispose of used electrical equipment as domestic waste.

But please do not dispose of them at official collecting points for recycling either!

All KLING & FREITAG products are plain business-to-business (B2B) products. KLING & FREITAG products labelled with a waste bin sign have thus to be disposed of by KLING & FREITAG GmbH alone. Please call KLING & FREITAG at the number stated below if you have a KLING & FREITAG product to be disposed of. We will offer you a straightforward and professional disposal with no costs involved.

If there is no waste bin sign on one of your KLING & FREITAG products, because it has been sold before 24 March 2006, then by law the owner is in charge of the disposal. In this case we will be happy to assist and offer you proper ways of disposal.

Telephone number to call about the disposal of used KLING & FREITAG products: +49 (0) 511-96 99 7-0

Explanation: With the ElektroG (law relating to electrical and electronic equipment and appliances) we have complied with the EU-directive on waste electrical and electronic equipment (WEEE, 2002/96/EC).

From 03/24/2006 onwards KLING & FREITAG GMBH has thus labelled all products mentioned in the WEEE with a sign with a crossed out waste bin and a white bar below. This sign indicates that the disposal as domestic waste is prohibited and that the product has been put into circulation on 03/24/2006 at the earliest.

KLING & FREITAG GMBH has been legally registered as a manufacturer with the German registration office EAR. Our WEEE registration number is: DE64110372.

For the German Registration office EAR we have accredited that our products are soleB2B products.

16.2 EU, Norway, Iceland, and Liechtenstein

It is not allowed to dispose of used electrical equipment as domestic waste.

From 08/13/2005 onwards KLING & FREITAG GMBH has thus labelled all products for EU-Member countries as well as Norway, Iceland and Liechtenstein (except Germany) mentioned in the WEEE with a sign with a crossed out waste bin and a white bar below.

This sign indicates that the disposal on domestic waste is prohibited and that the product has been put into circulation on 08/13/2005 at the earliest.

Unfortunately the European directive WEEE has been complied with implementing different national provisions of law throughout all member countries, which makes it impossible for us to offer consistent solutions for the disposal throughout Europe.

Responsible for complying with these provisions of law is the local distributor (importer) of each country.

For proper disposal of used products in accordance with these local provisions in the mentioned countries of the European Union (except Germany) please ask your local dealer or the local authorities.

16.3 All other Countries

For proper disposal of used products in accordance with local provisions in other than the above mentioned countries please ask your local dealer or the local authorities.

17. EC Declaration of Conformity

for the products mentioned hereafter.

Digital system controller:

CD 24 *)
CD 44

*) This product is discontinued.

We declare that the listed products are in conformity with the protection requirements of the following directives:

Electromagnetic Compatibility Directive (EMC)	(2004/108/EC)
Low Voltage Directive (LVD)	(2006/95/EC)
Technical documentation for the assessment of electrical and electronic products with respect to the restriction of hazardous substances	(VDE 0042-12:2013-02)

Conformance of the products with the requirements is approved by compliance with the following harmonized European standards:

DIN EN 50581	:2012
DIN EN 55103-1	:1996
DIN EN 55103-2	:1996
DIN EN 61000-3-3	:1998 + A1:2000 + A2:2003
DIN EN 55022	:2000 + A1:2001
DIN EN 61000-3-2	:1995 + A1:2001
DIN EN 61000-3-3	:1995 + A1:1998
DIN EN 61000-4-2	:2002 + A1:2002
DIN EN 61000-4-3	:1995 + A1:2001 + A2:2001
DIN EN 61000-4-4	:1995 + A1:2001:1996 + A1:2001
DIN EN 61000-4-5	:1994
DIN EN 61000-4-6	:2001
DIN EN 61000-4-11	DE 3 - 82127
IEC 60065	

Accredited Testing Laboratory:	PHOENIX TESTLAB Königswinkel 10 D-32825 Blomberg Germany
---------------------------------------	---

The operating conditions specified in the user's manual must be met accordingly.

This declaration is issued under the sole responsibility of the manufacturer:

KLING & FREITAG GmbH
Junkersstraße 14, 30179 Hannover, Germany



Hannover, 16th May 2013

Jürgen Freitag
(Managing Director / CEO)